

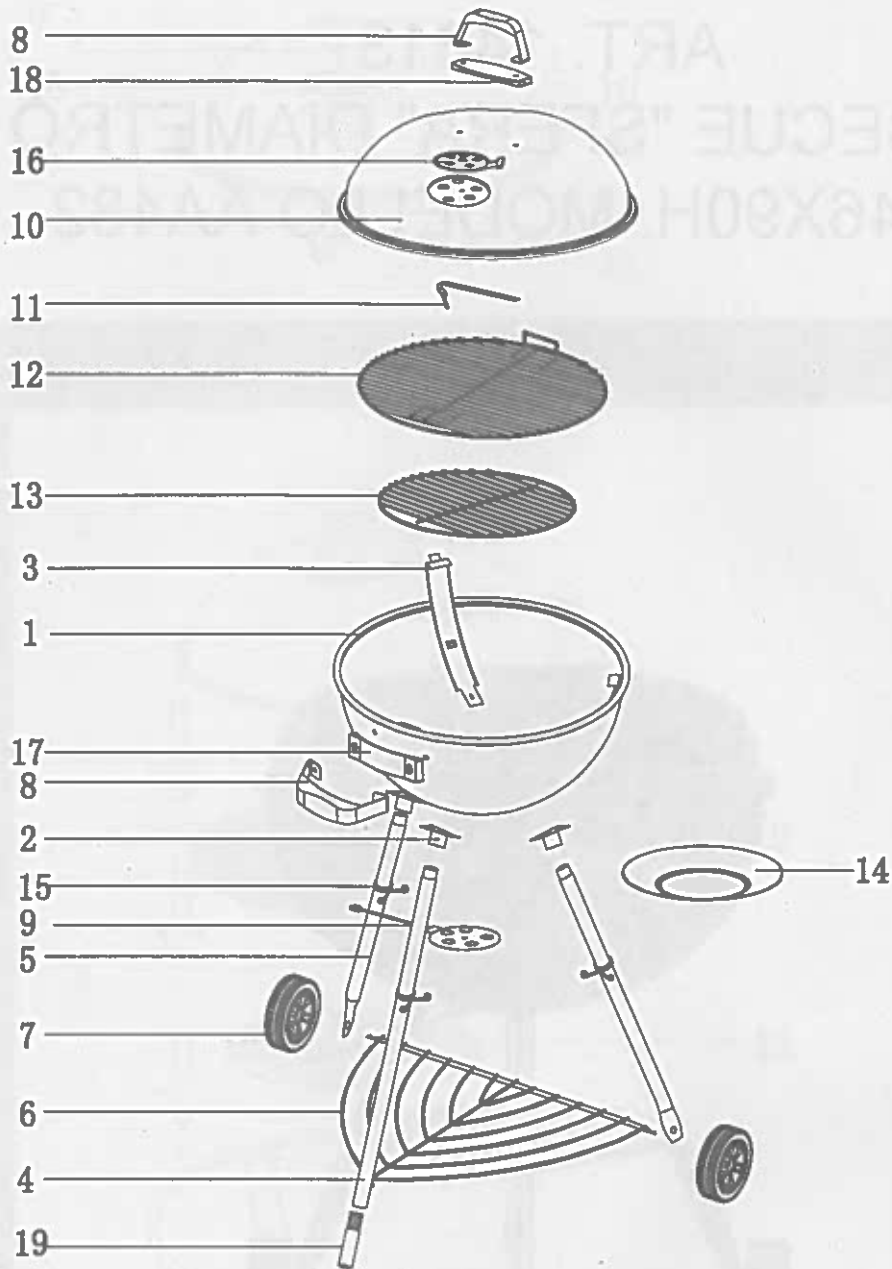























ISTRUZIONI DI MONTAGGIO
ART. 14613
BARBECUE "SFERA" DIAMETRO
CM.46X90H. MODELLO AA482





- | | | | |
|--|---|--|--|
| 1 (X1)  | 7 (X2)  | 13 (X1)  | A (X6) M6X12  |
| 2 (X3)  | 8 (X2)  | 14 (X1)  | B (X3) M6X20  |
| 3 (X3)  | 9 (X1)  | 15 (X3)  | C (X2) M8  |
| 4 (X1)  | 10 (X1)  | 16 (X1)  | D (X2) M5X10  |
| 5 (X2)  | 11 (X1)  | 17 (X1)  | E (X4) M6X20  |
| 6 (X1)  | 12 (X1)  | 18 (X1)  | |
| | | 19 (X1)  | |

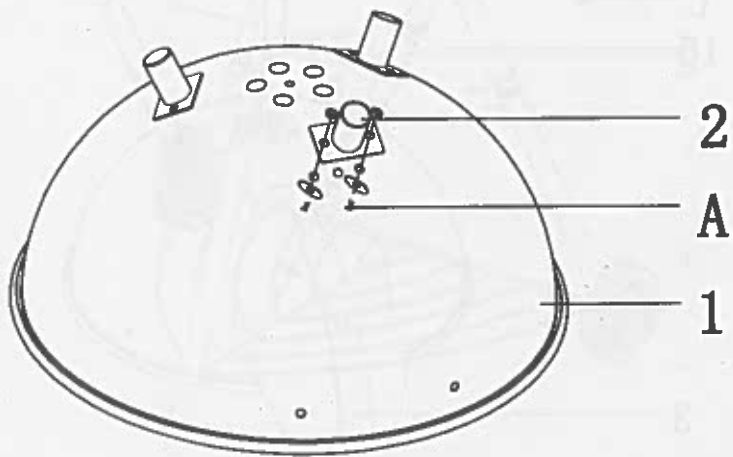
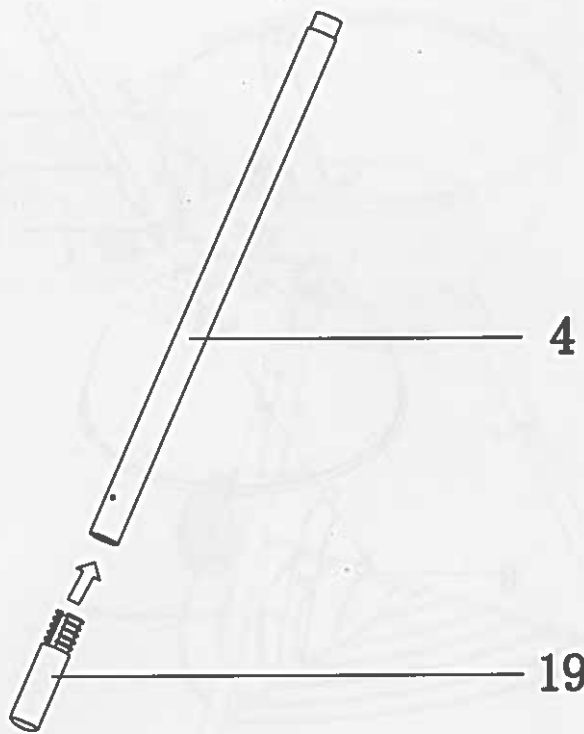

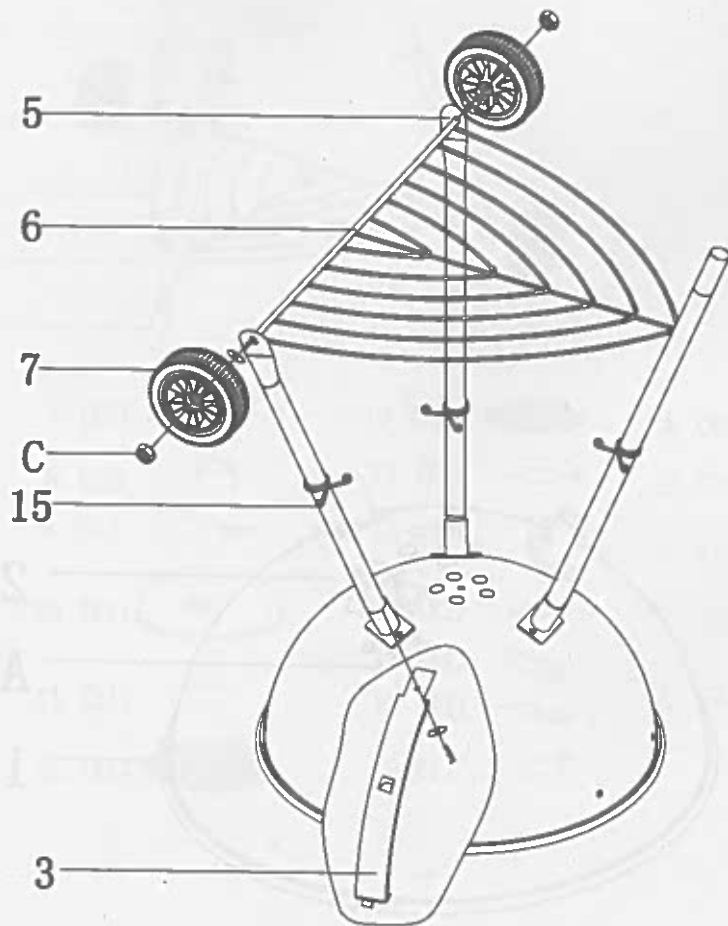
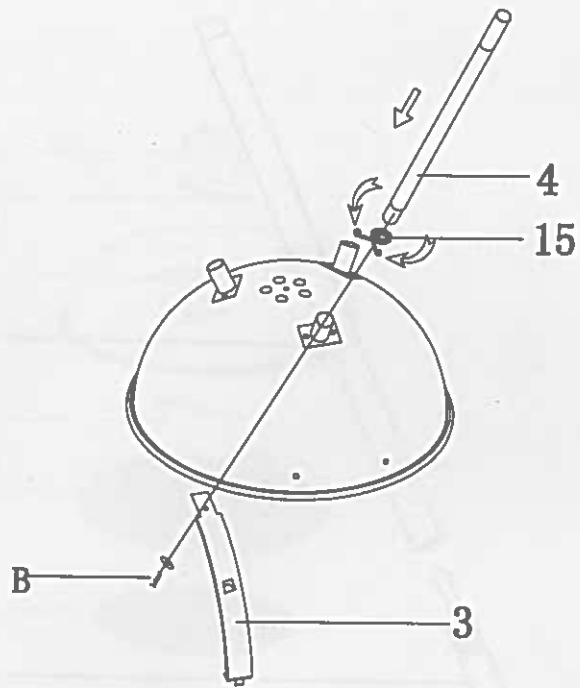

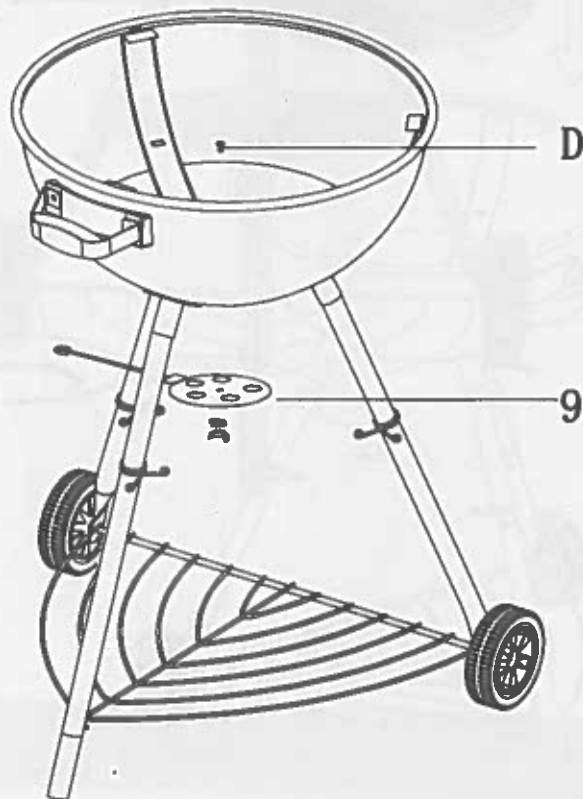
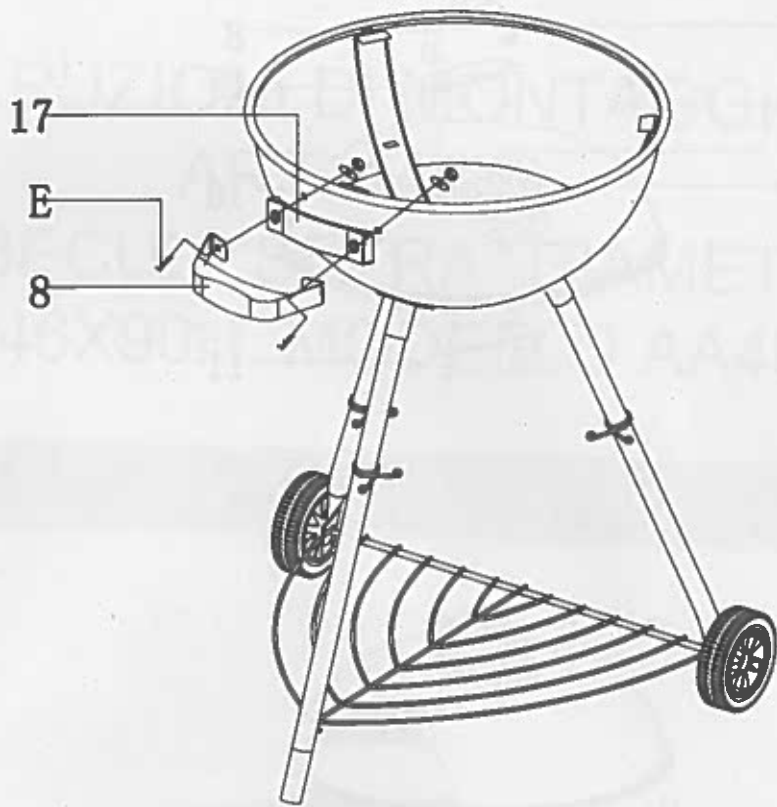

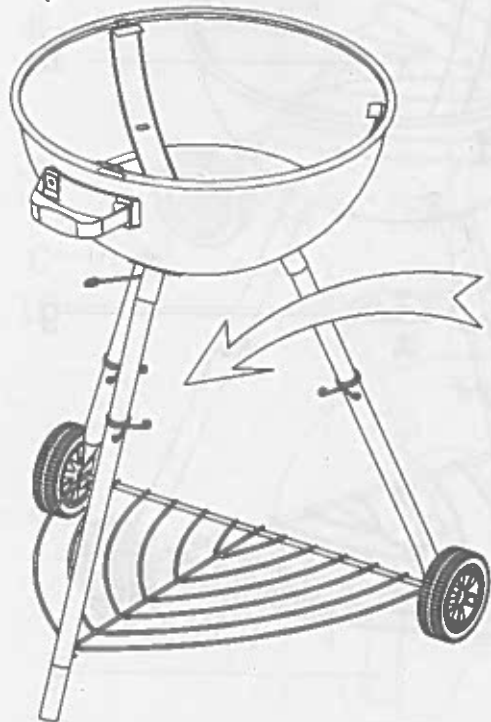
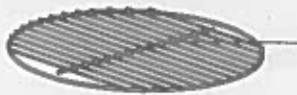
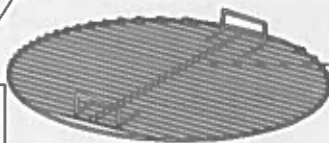
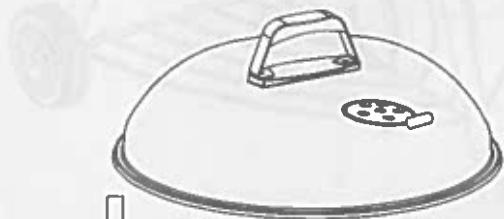
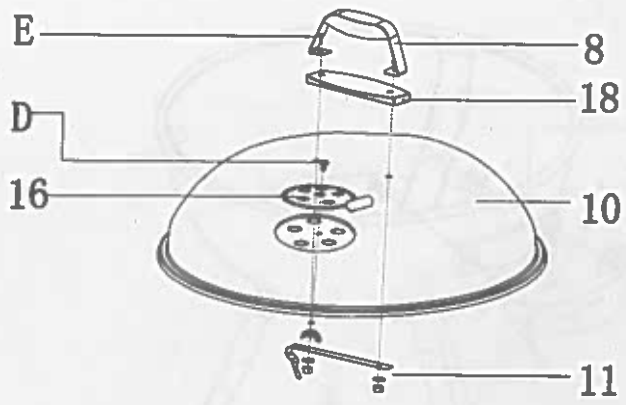

14