

6621

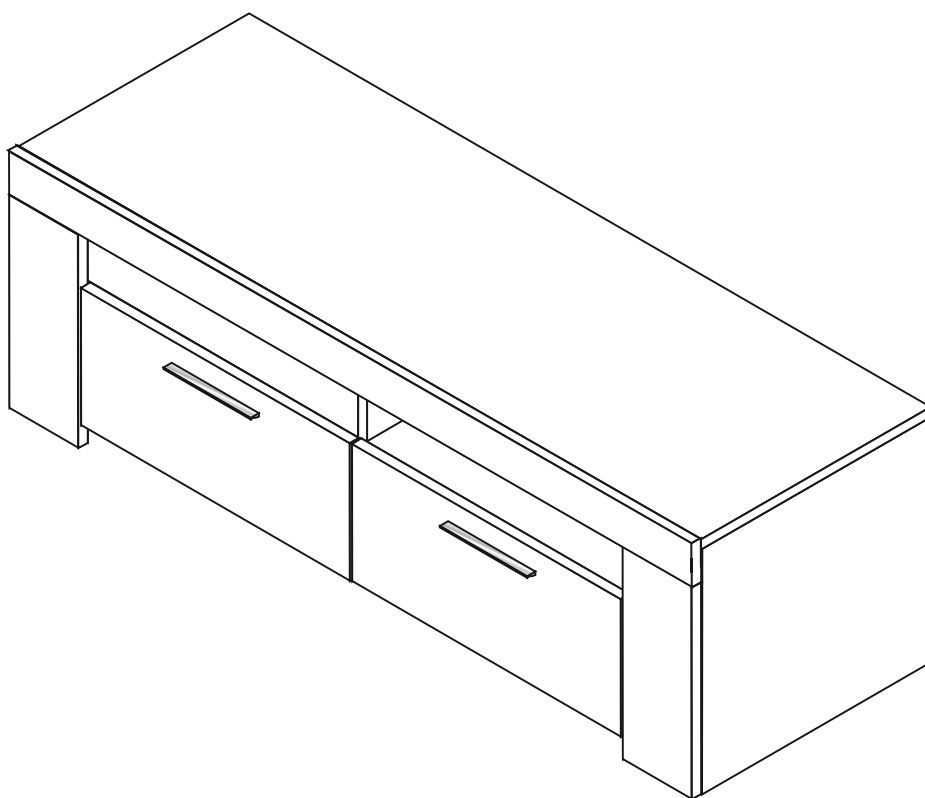

**SALÓN TV - TV LIVING ROOM - SÉJOUR TV - MÓVEL PARA SALA -
TV SOGGIORNO - FERNSEHRAUM - NAMJEŠTAJ ZA TV - ΈΠΙΠΛΑ ΓΙΑ ΤΟ ΣΑΛΟΝΙ**

**INSTRUCCIONES DE MONTAJE - ASSEMBLING INSTRUCTIONS - NOTICE DE MONTAGE- INSTRUÇÕES DE MONTAGEM -
ISTRUZIONI DI MONTAGGIO - MONTAGEANLEITUNG - UPUTE ZA MONTAŽU - ΟΔΗΓΙΕΣ ΣΥΝΑΡΜΟΛΟΓΗΣΗΣ**

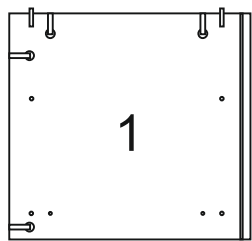
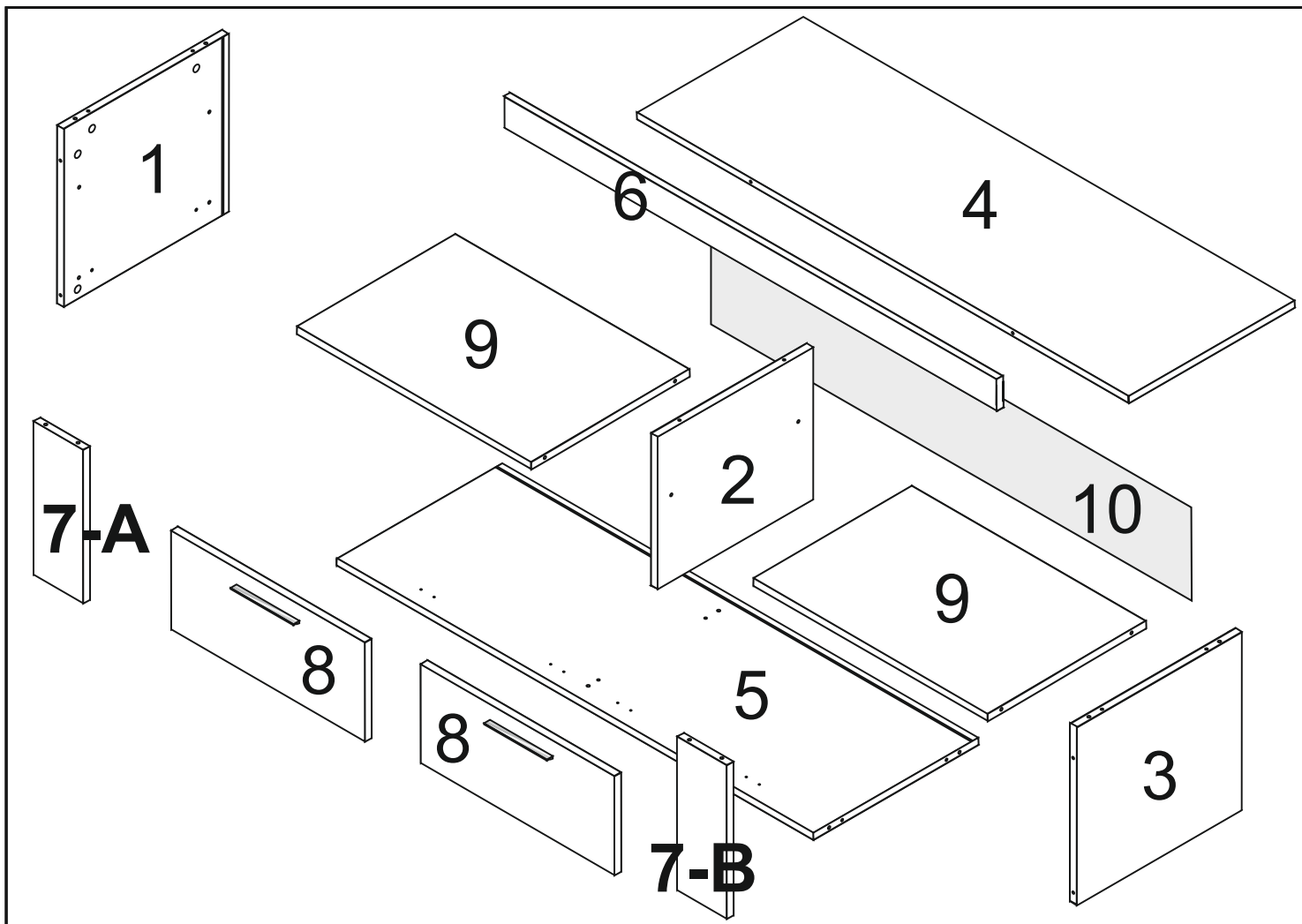

379 x 405 mm

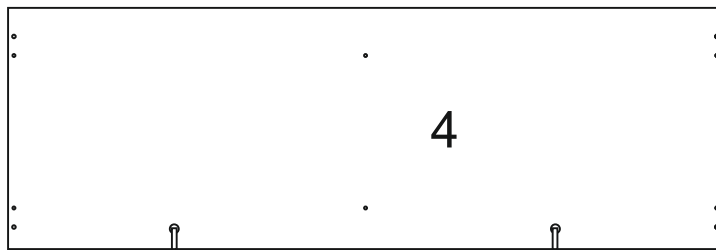

1198 x 405 mm

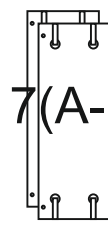

328 x 120 mm

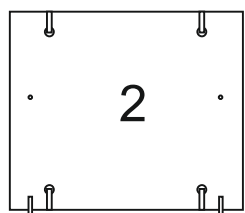

332 x 391 mm

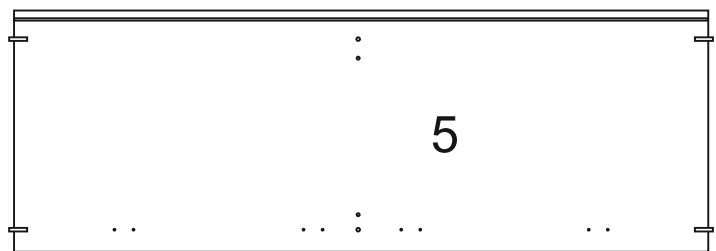

1167 x 405 mm

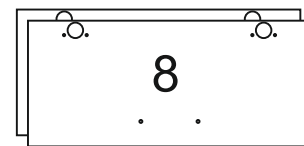

476 x 210 mm

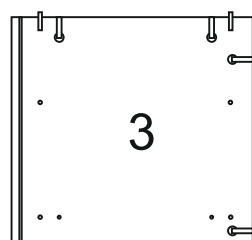

379 x 405 mm

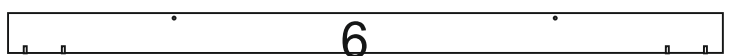

1199 x 67 mm



576 x 390 mm

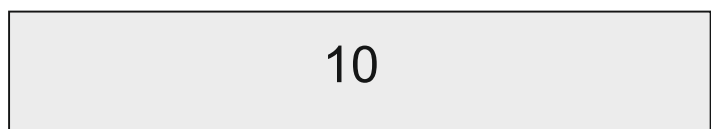

1178 x 201 mm

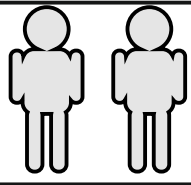
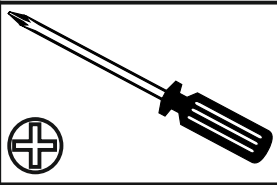
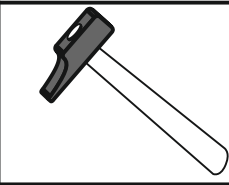
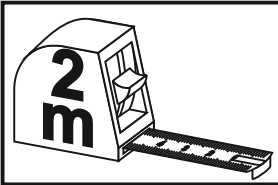

2 h.

A x 18

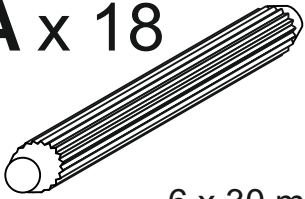

6 x 30 mm

E x 22

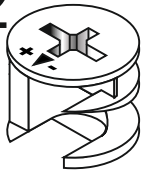

F x 22

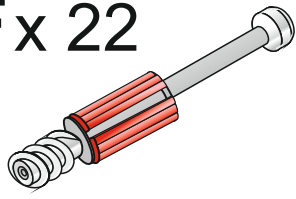

G x 2

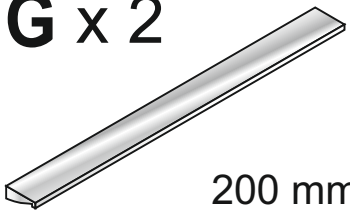

200 mm

K x 4

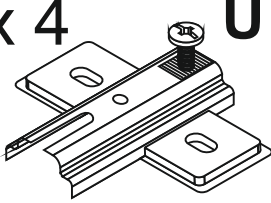

U

N x 6

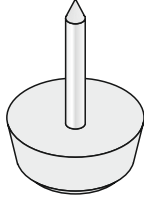

P x 8

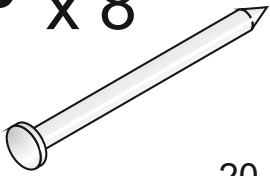

20 mm

V x 2

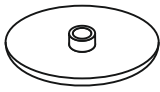

15 mm

W x 1

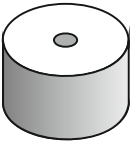

X x 1

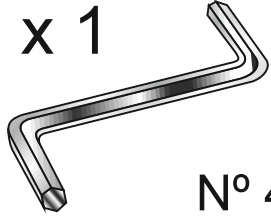

N° 4

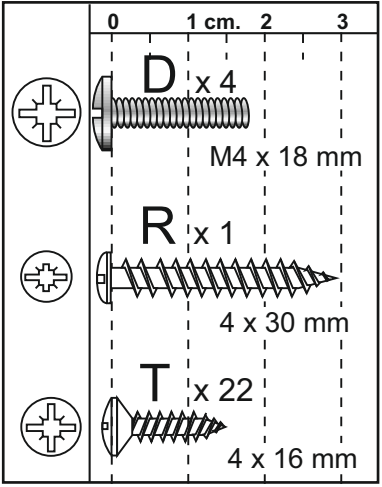

Z x 6

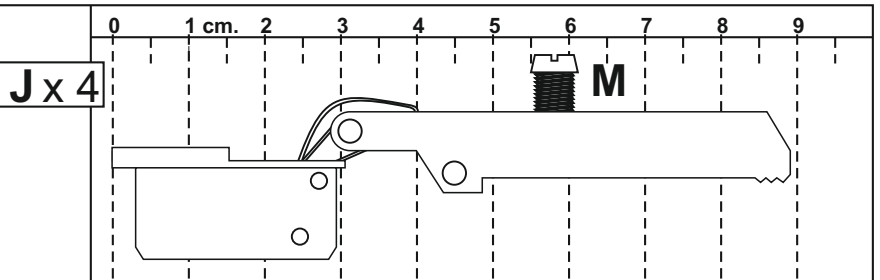
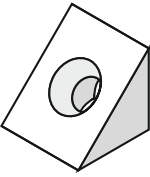

1

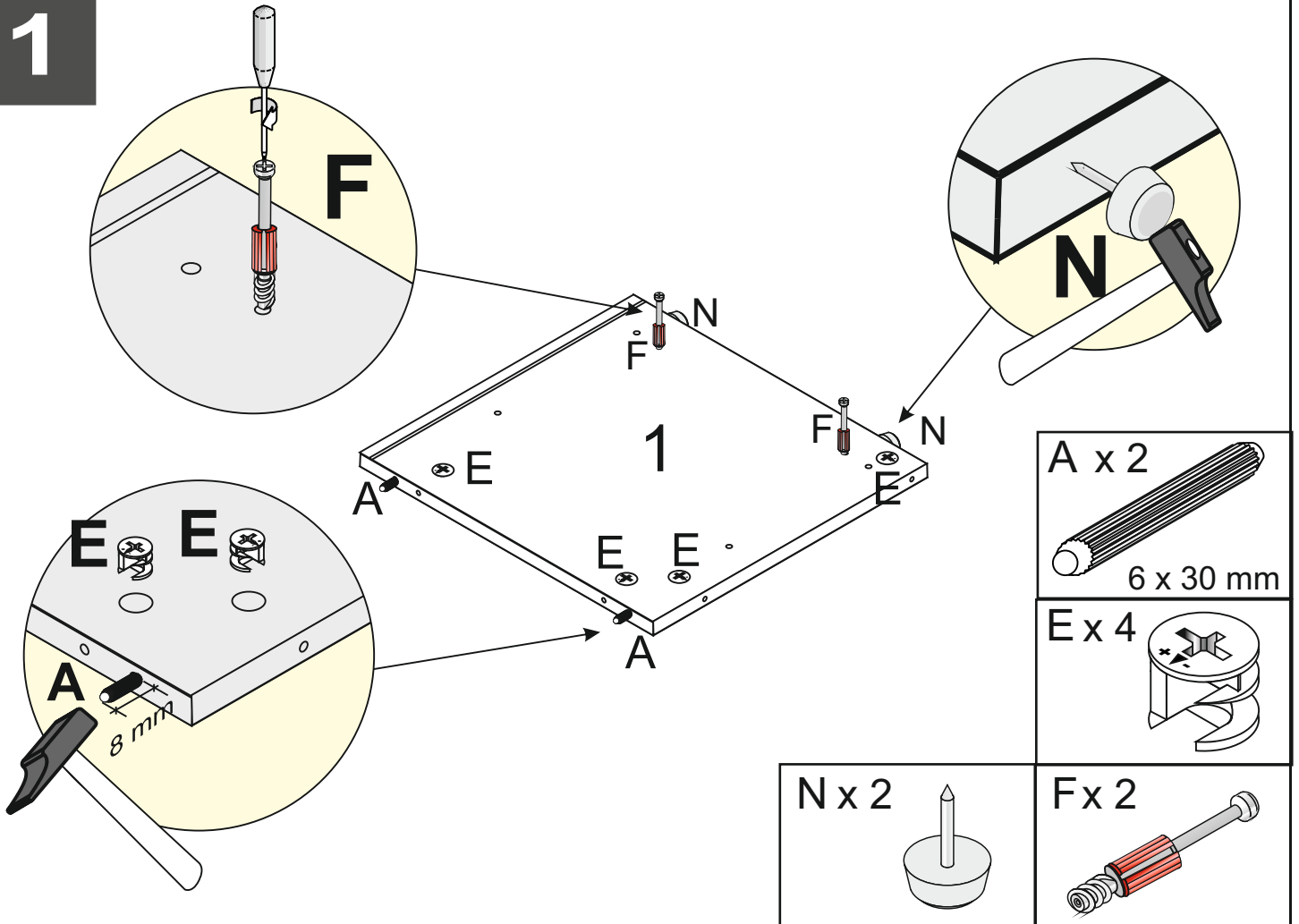

2

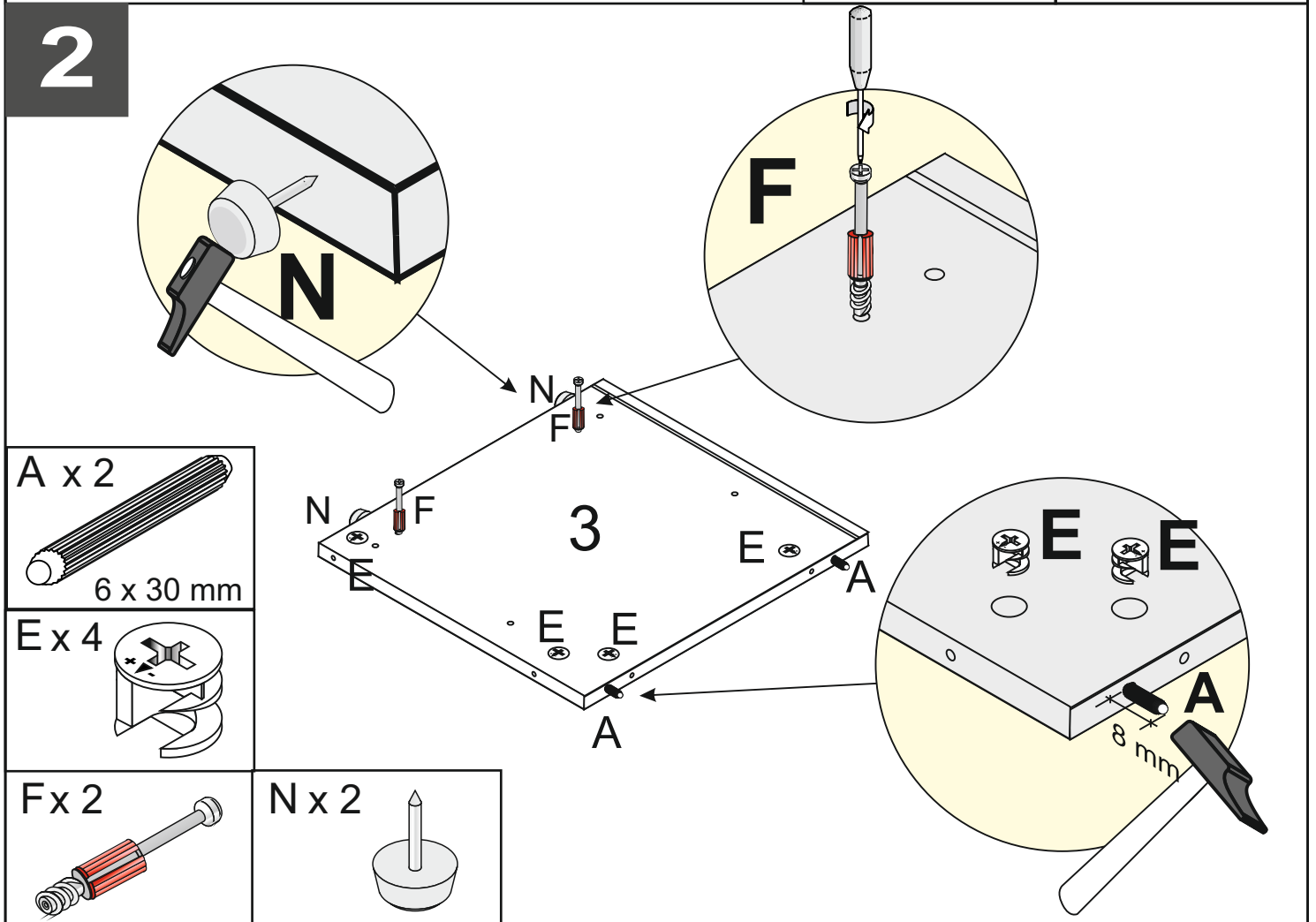

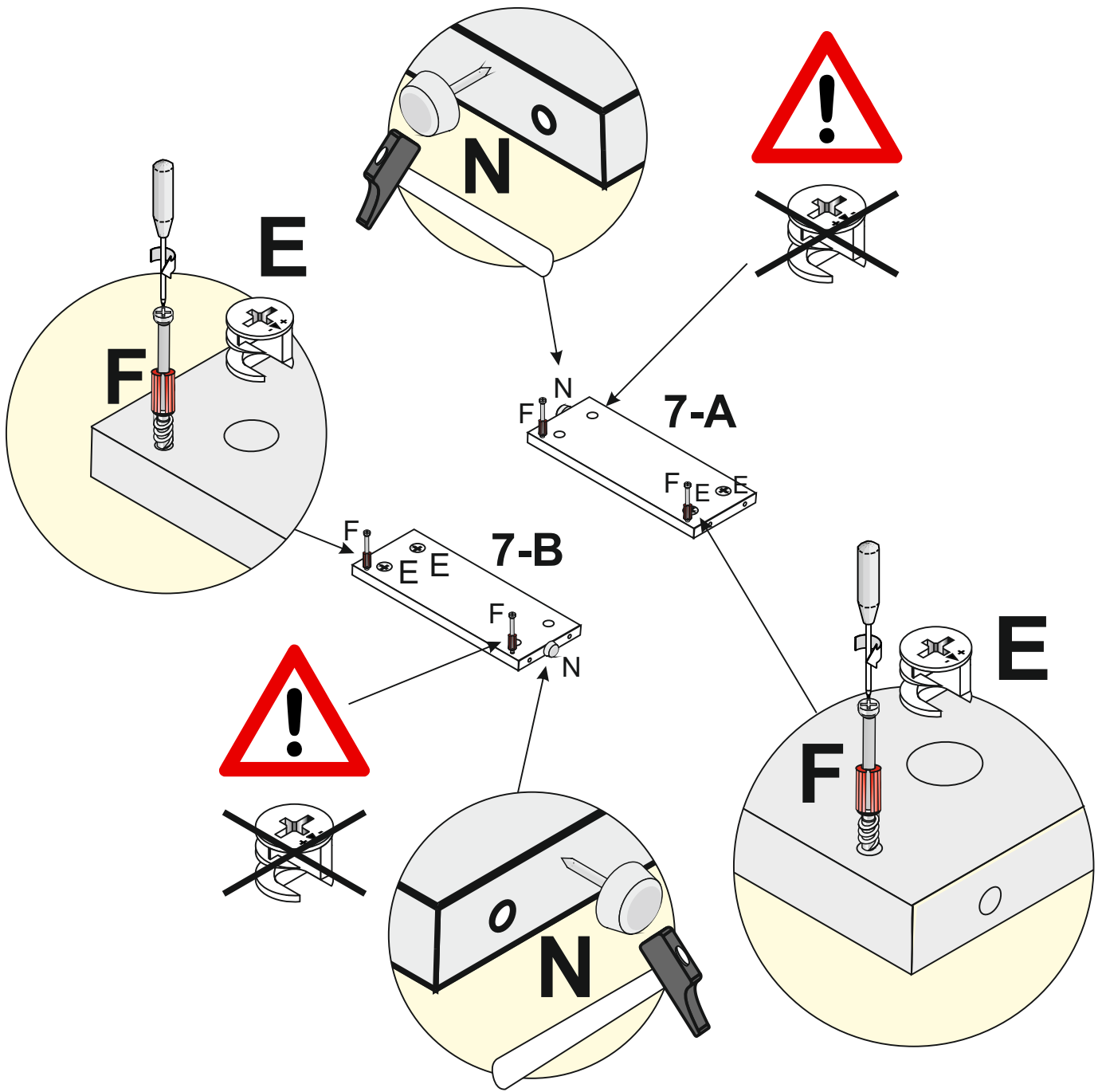

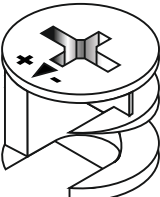
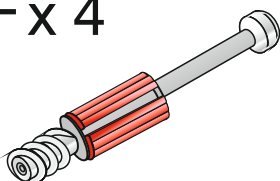
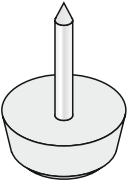
E x 4 	F x 4 	N x 2 
---	--	---

4

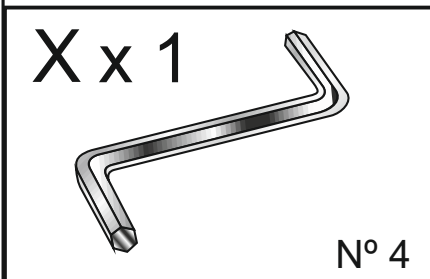
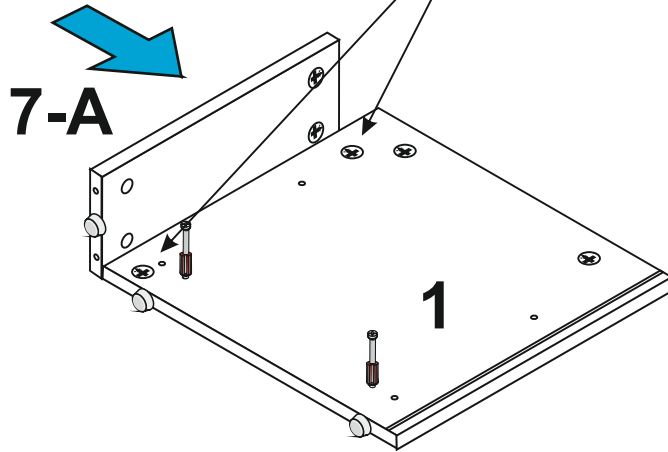
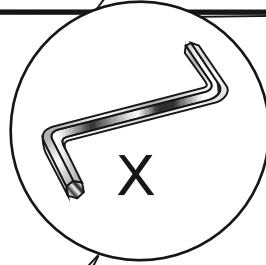
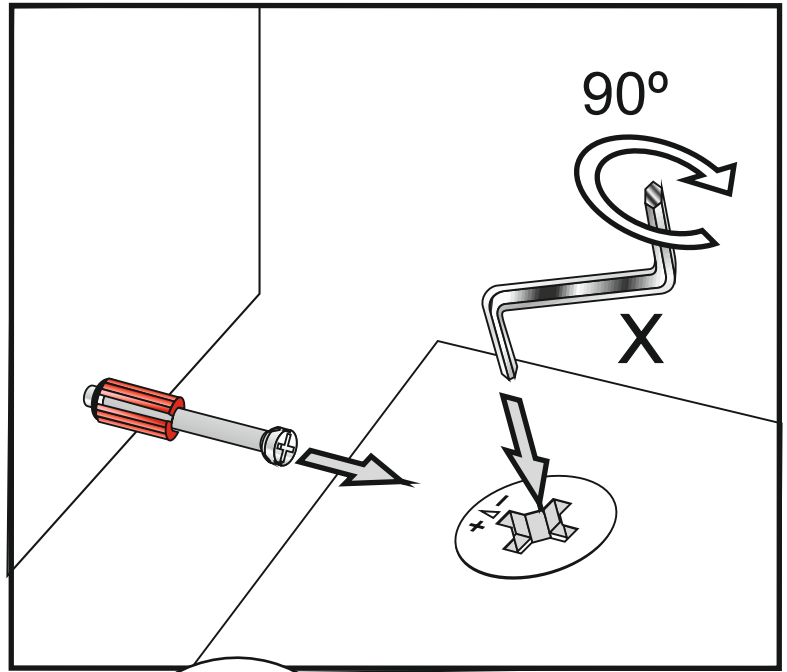

5

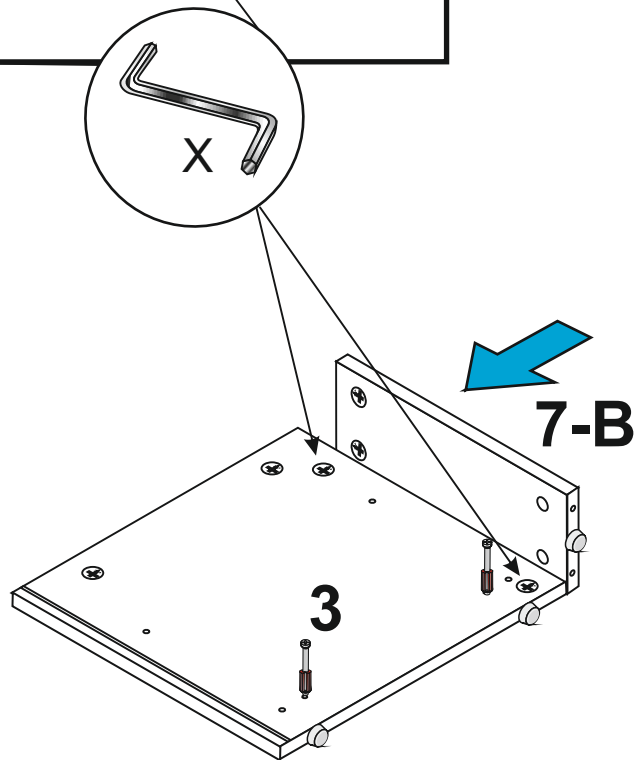
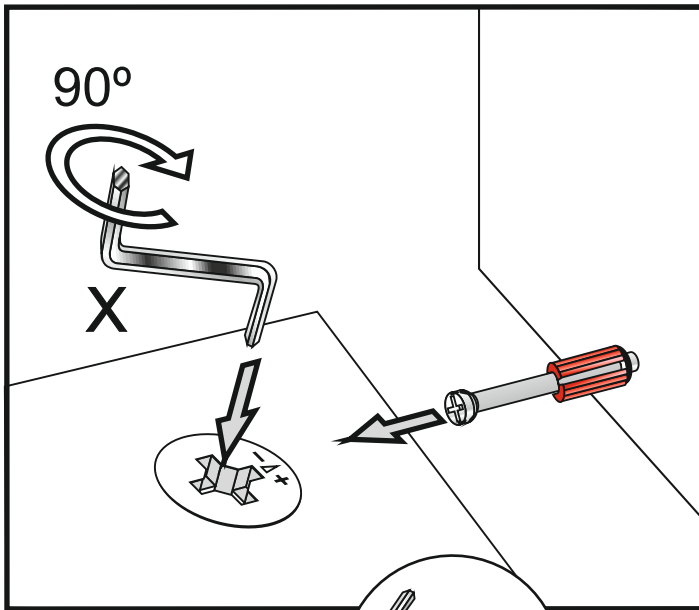

X x 1

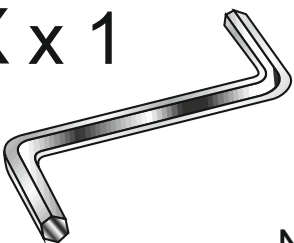

N° 4

6

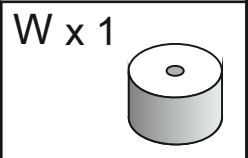
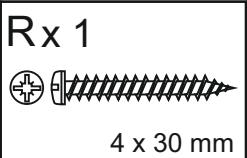
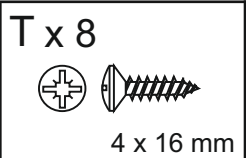
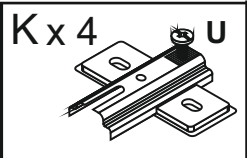
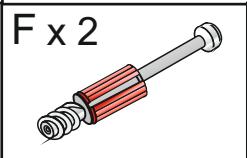
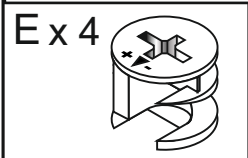
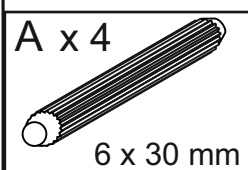
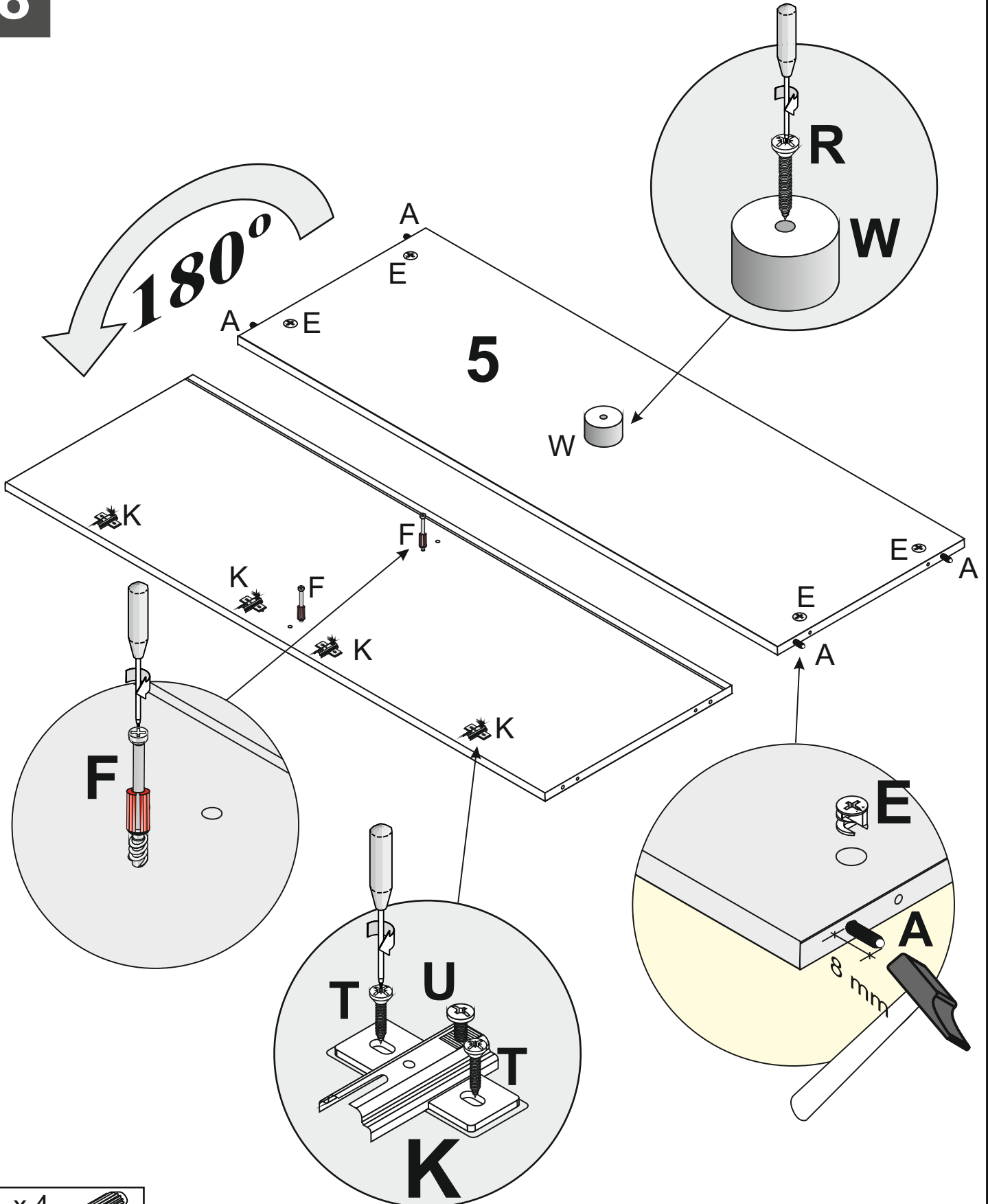

7

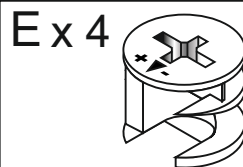
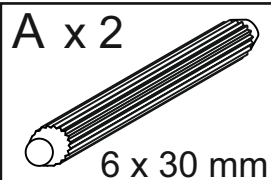
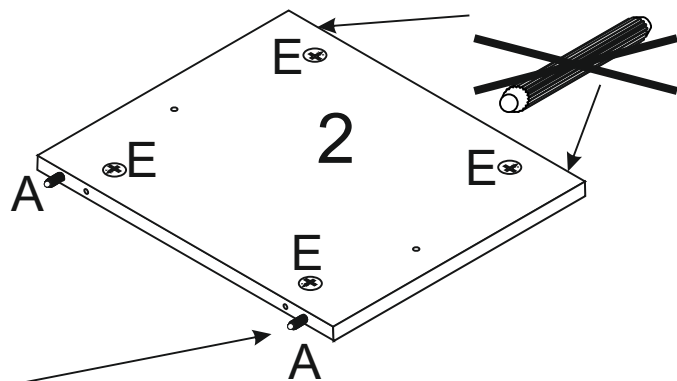
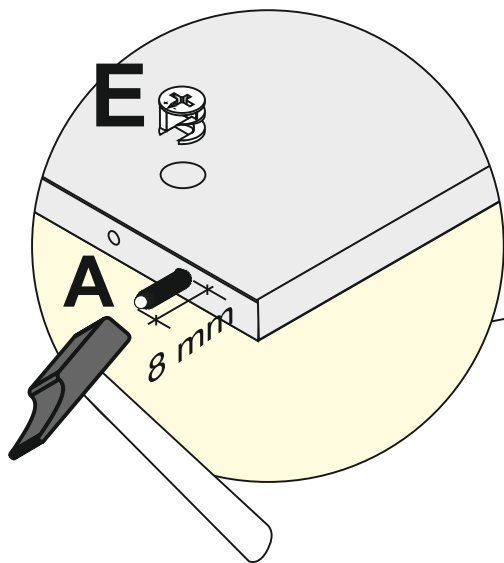

8

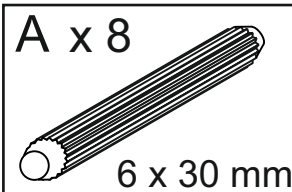
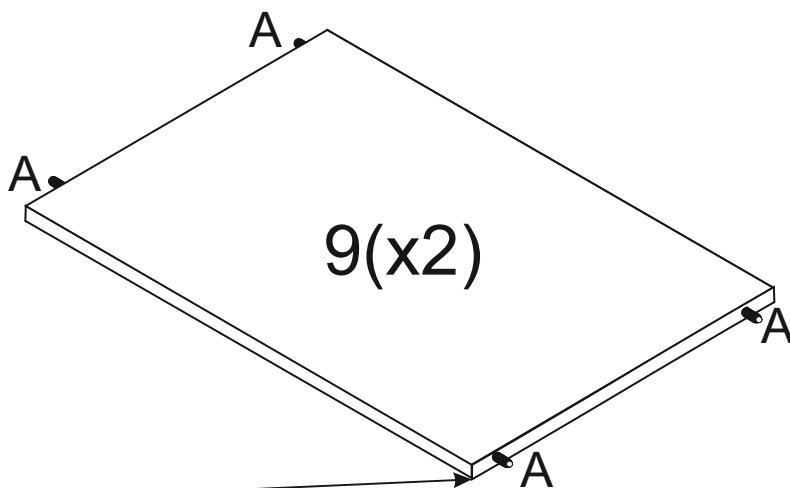
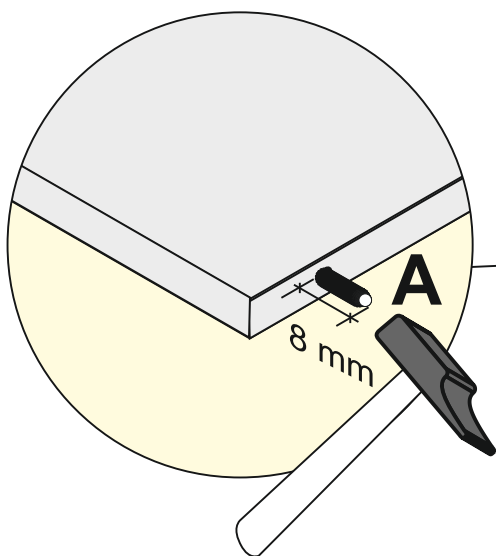

9

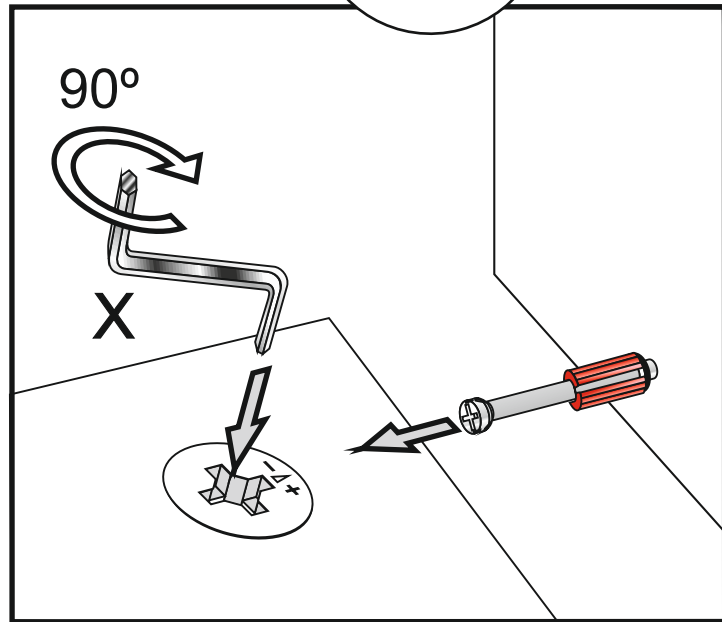
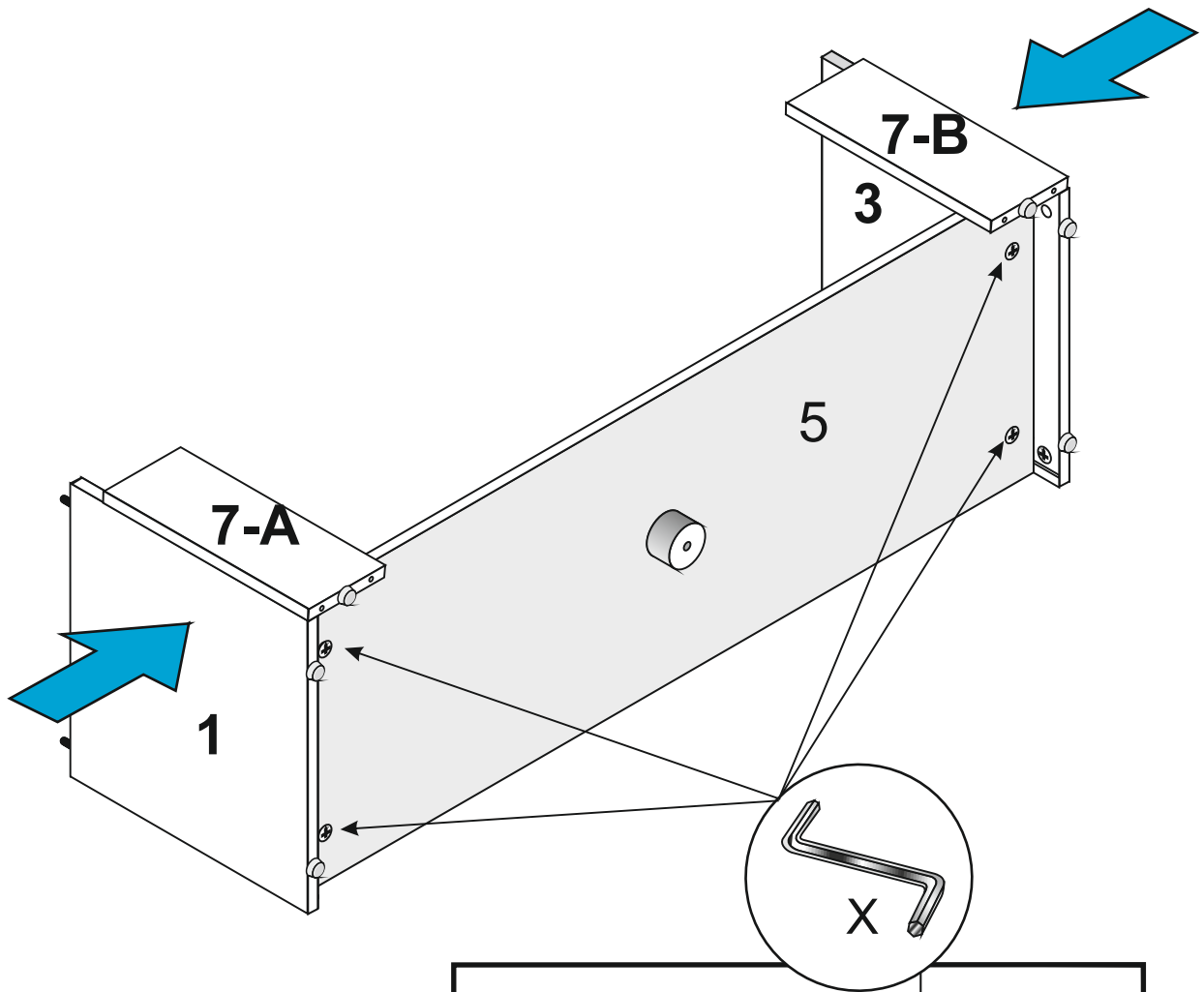

X x 1

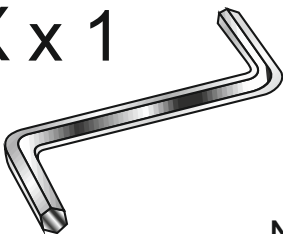

N° 4

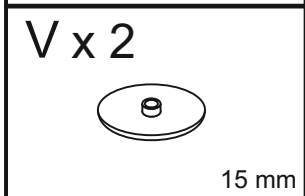
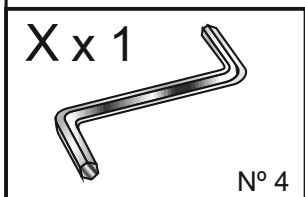
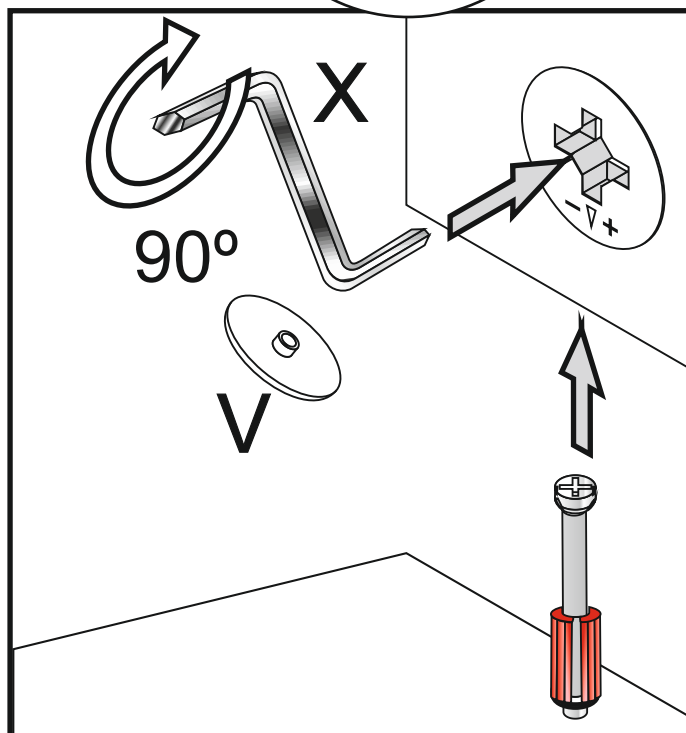
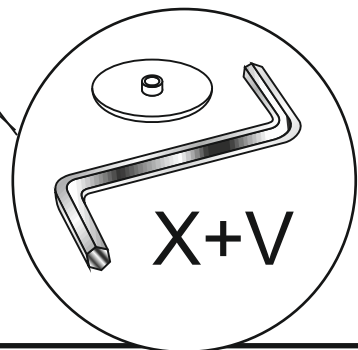
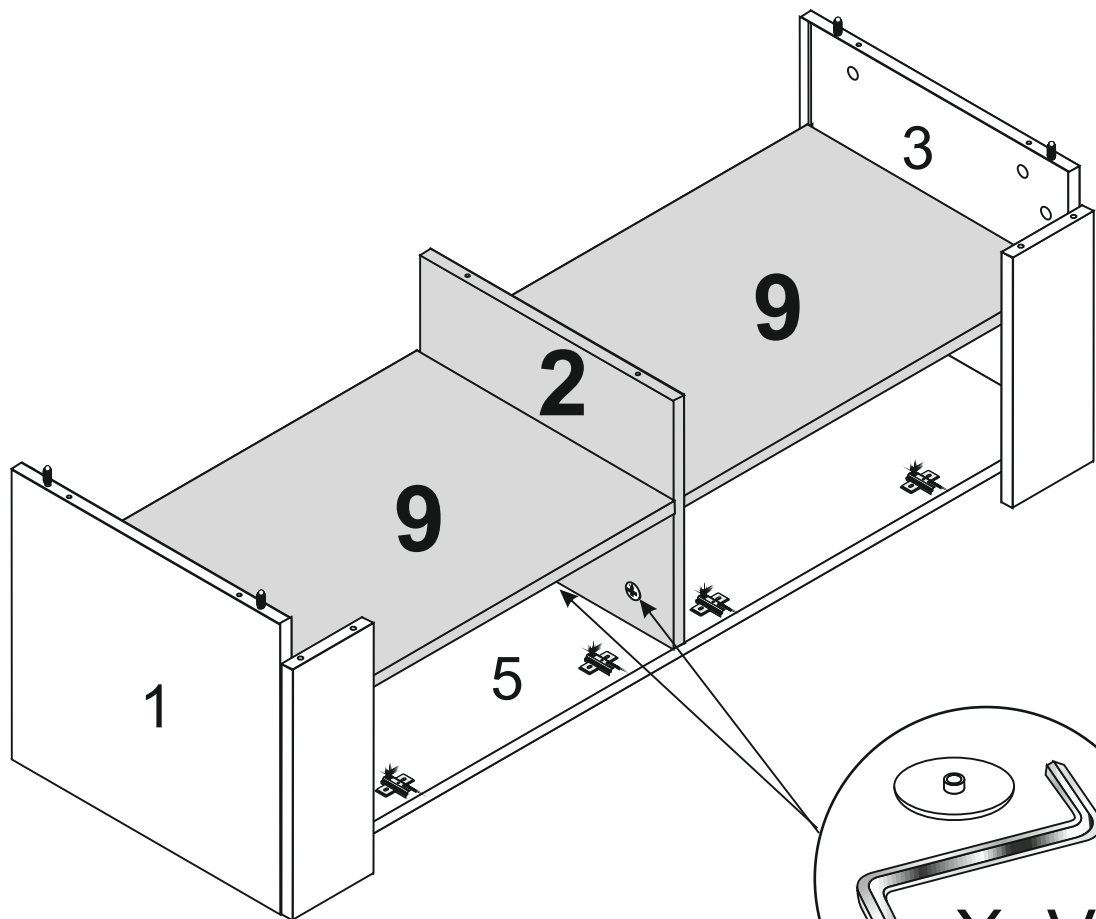

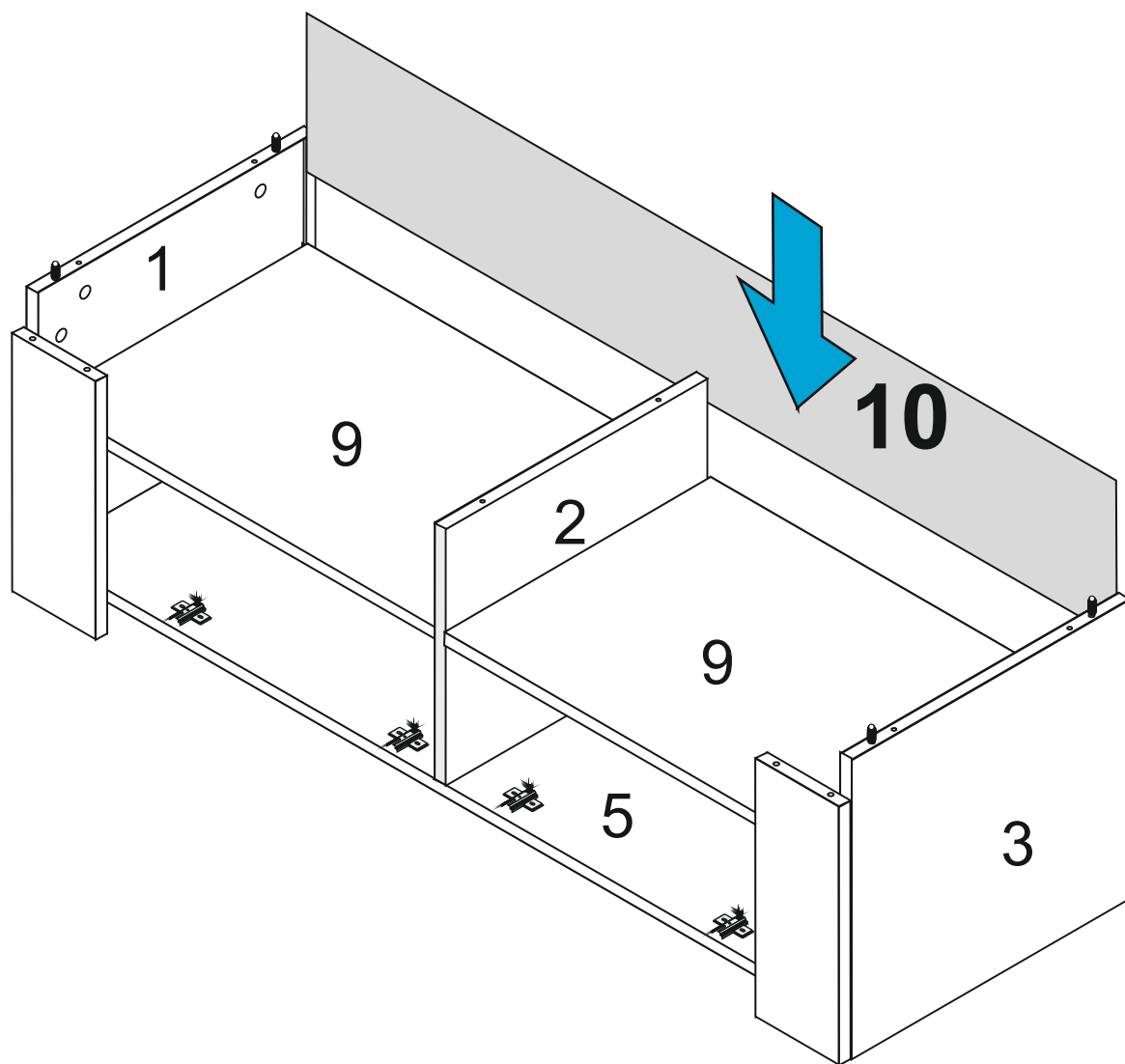

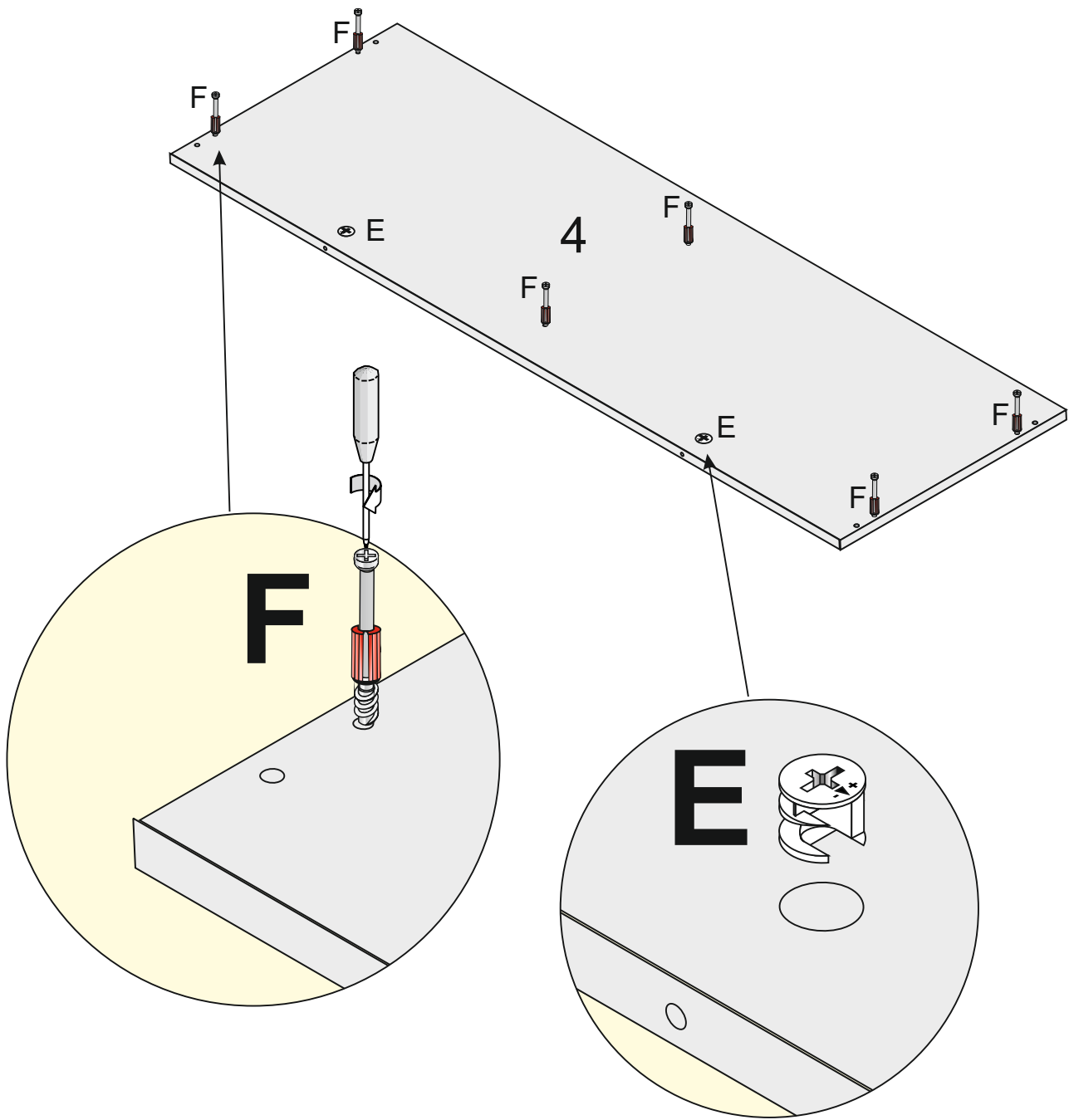

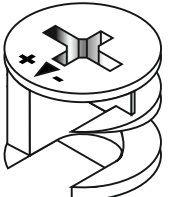
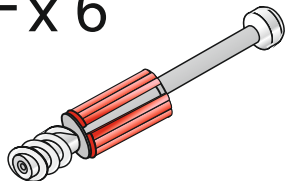
<p>E x 2</p> 	<p>F x 6</p> 
---	---

13

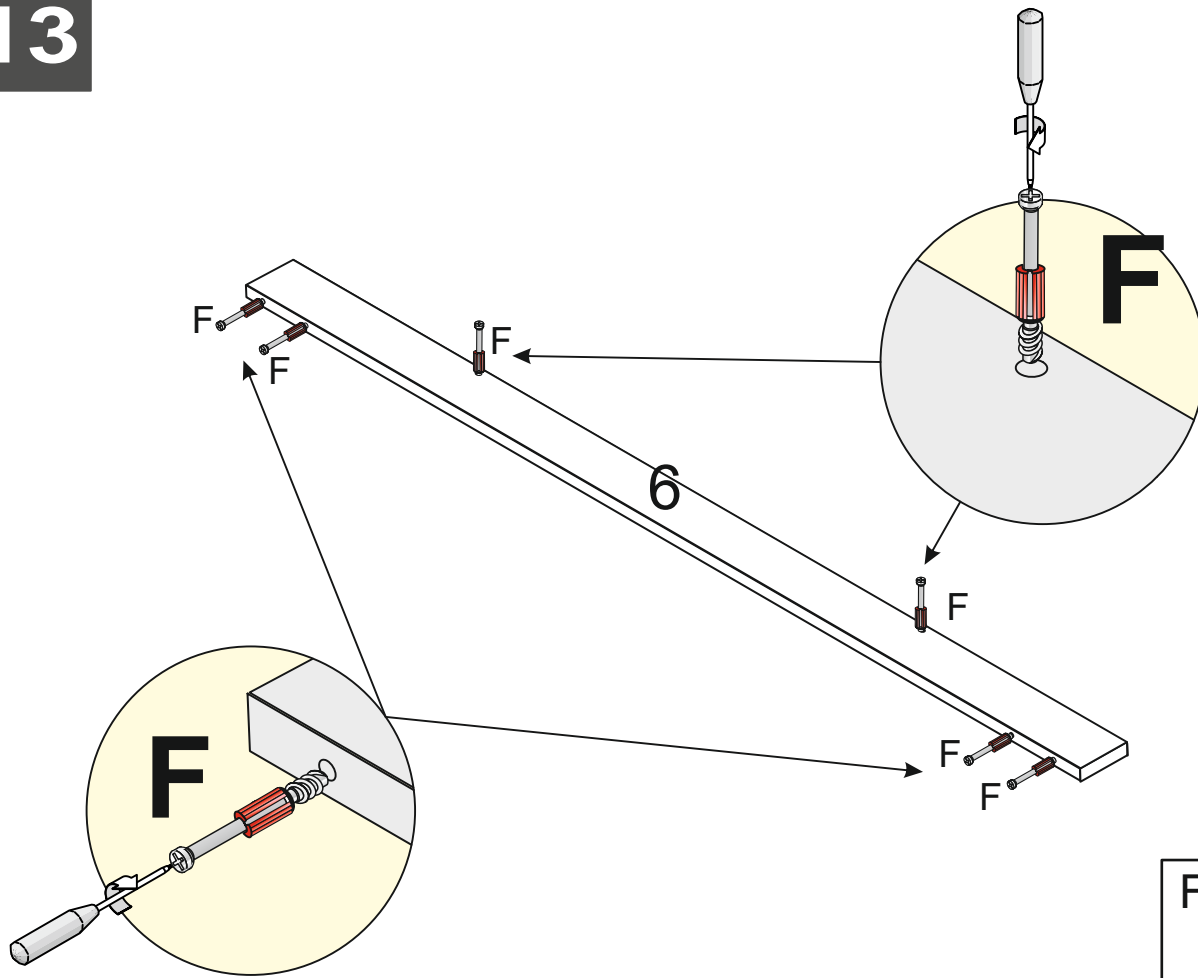

F x 6

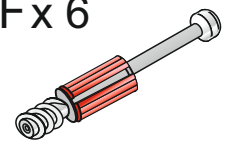

14

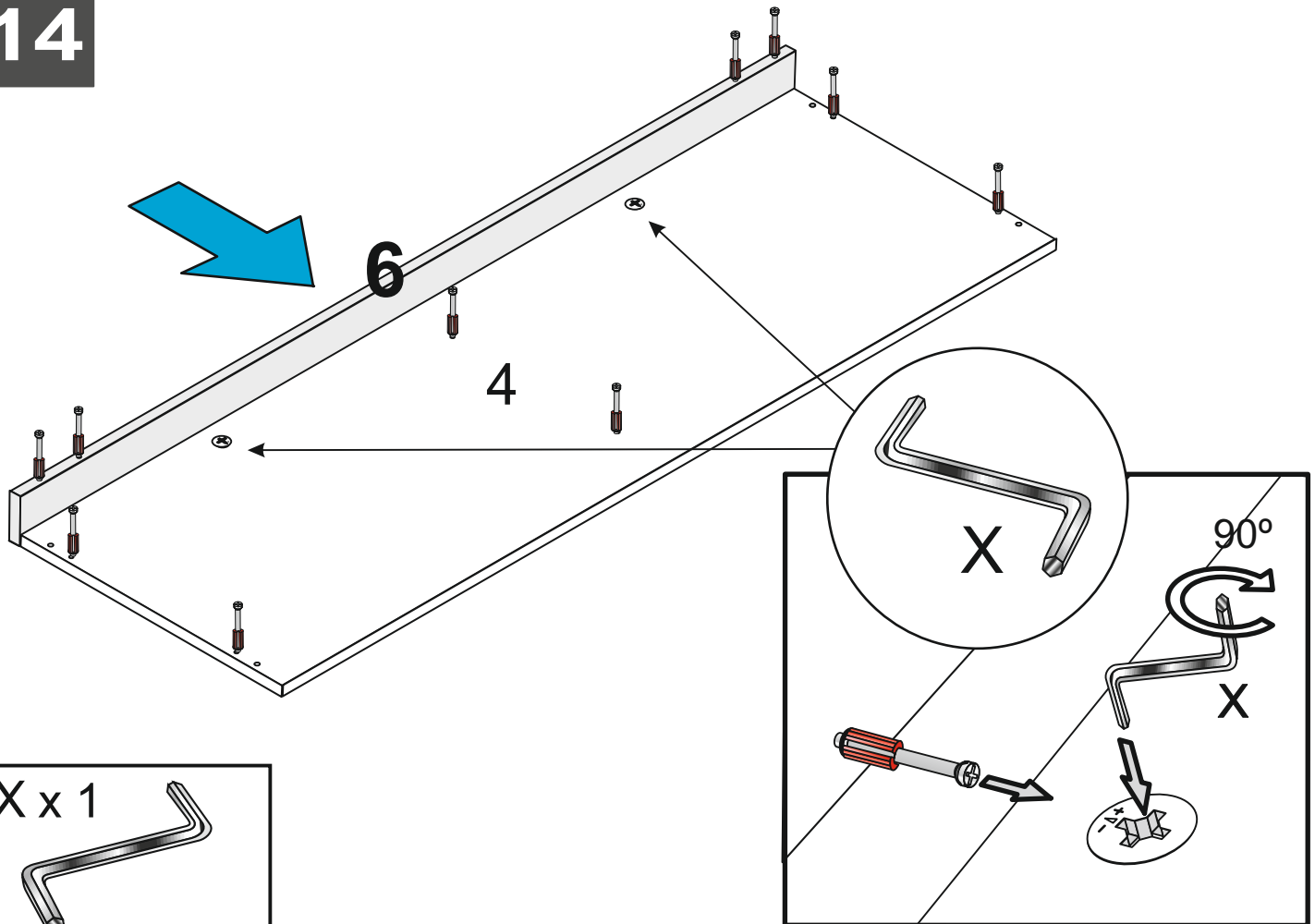

X x 1

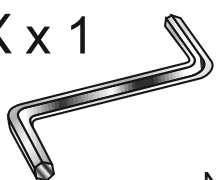

N° 4

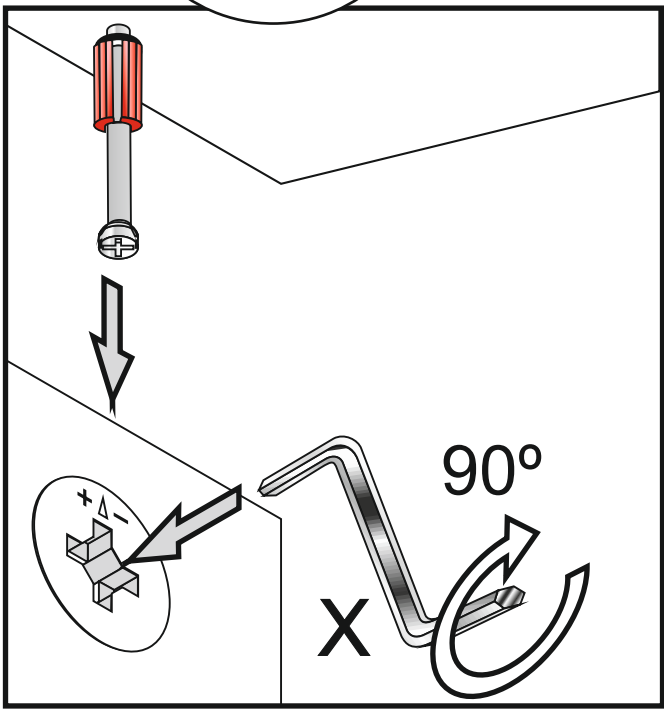
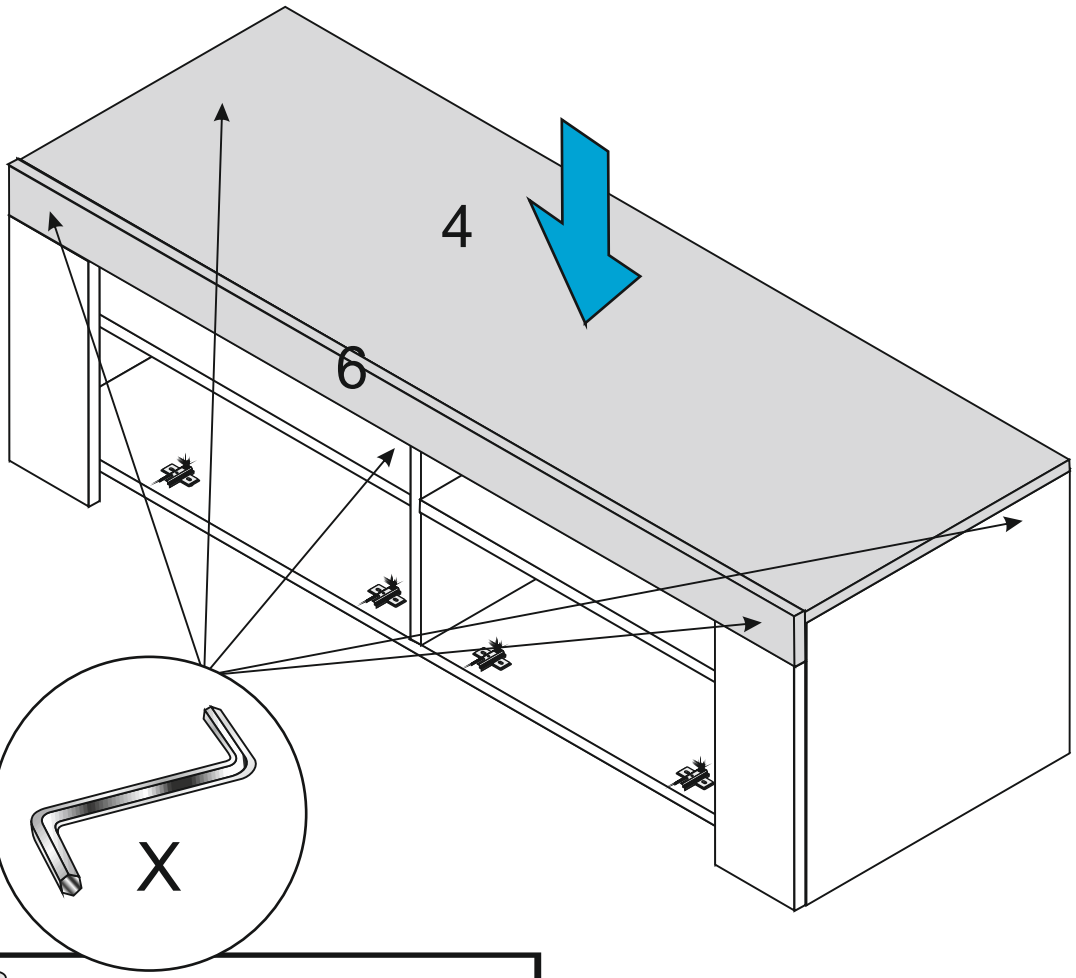
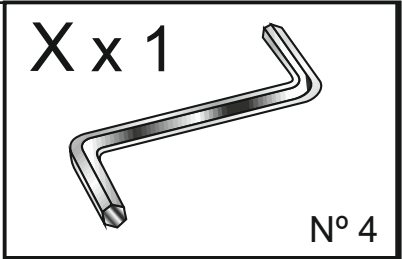

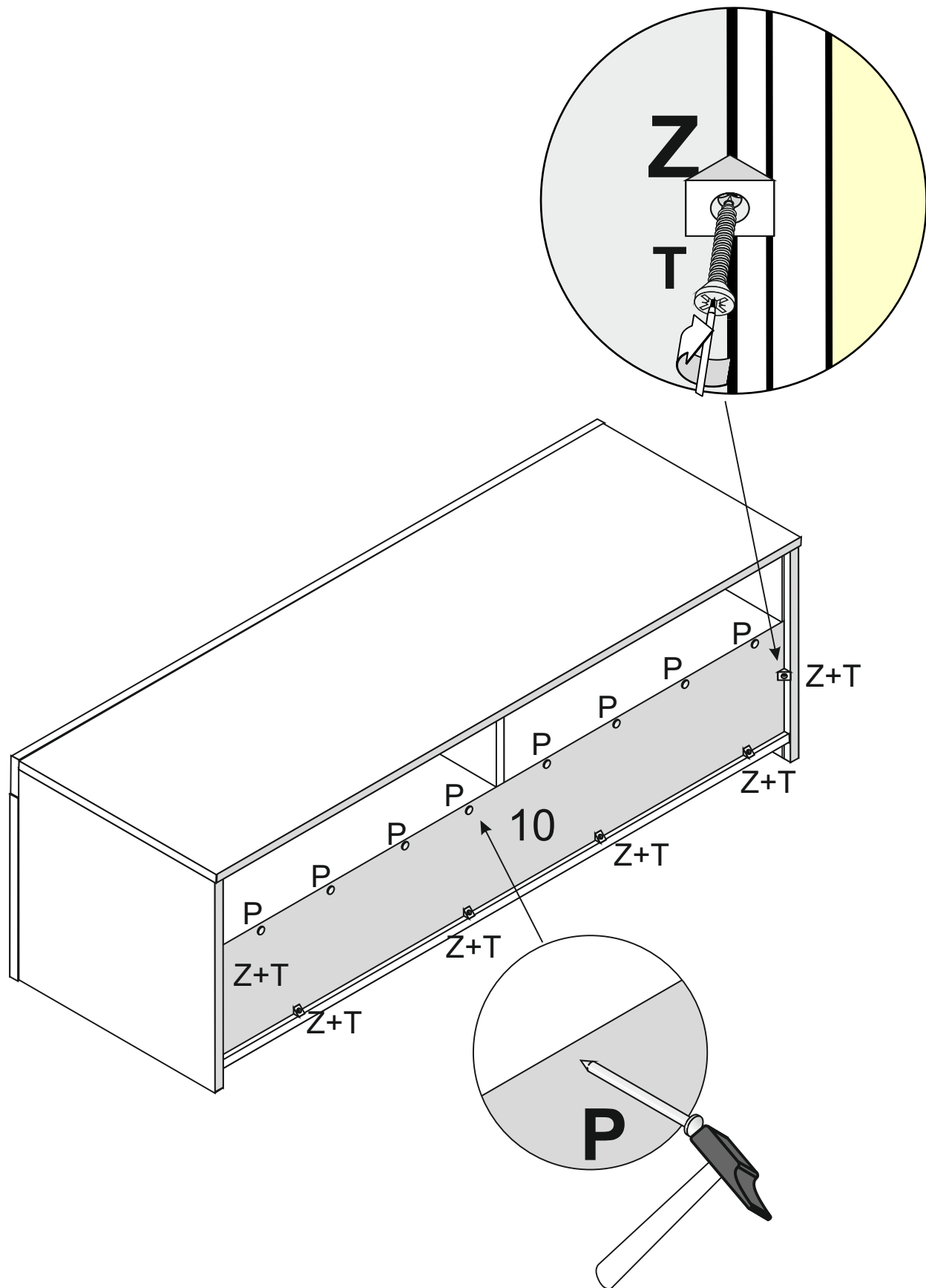

Z x 6

T x 6

4 x 16 mm

P x 8

20 mm

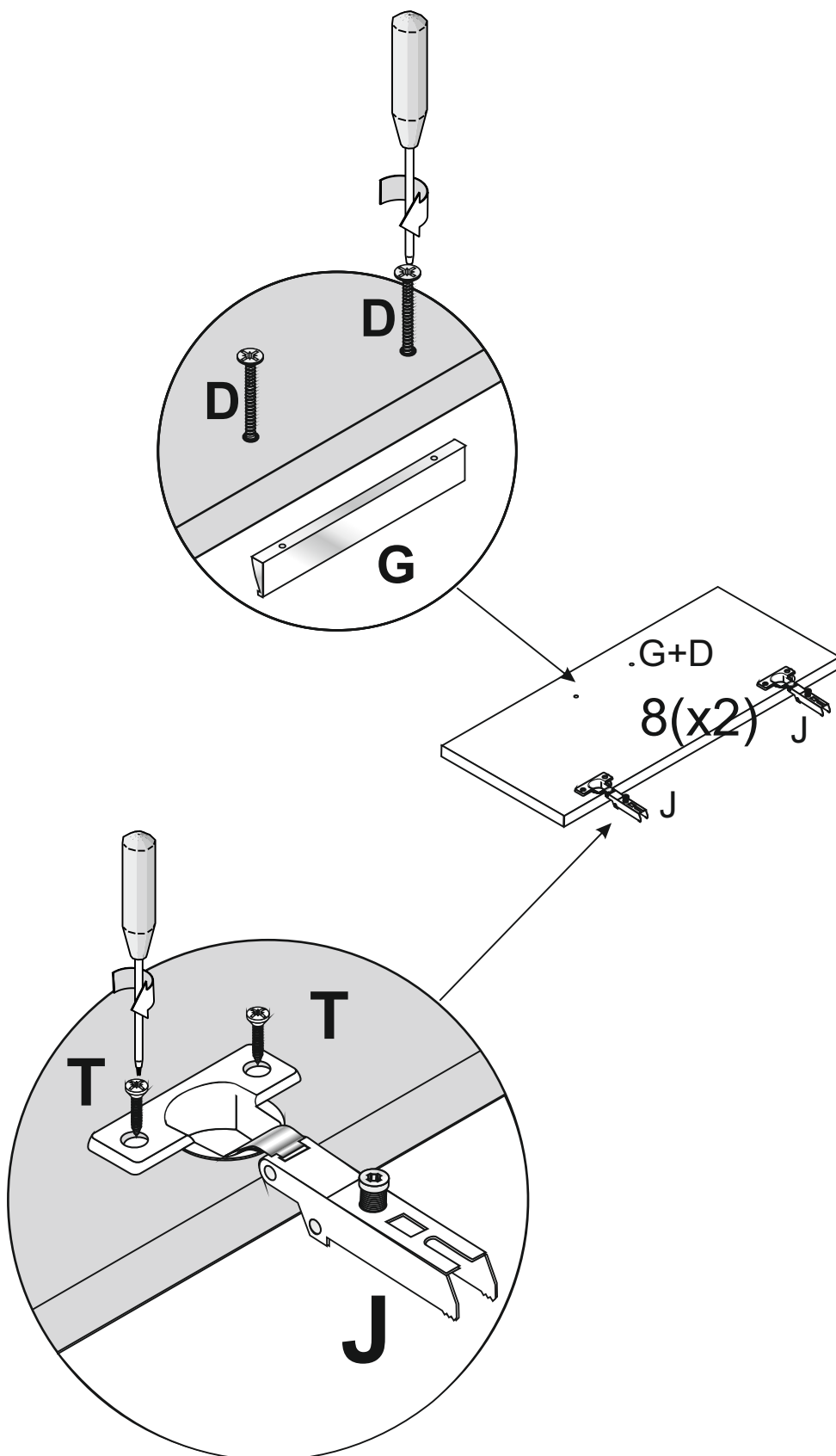

D x 4



M4 x 18 mm

G x 2

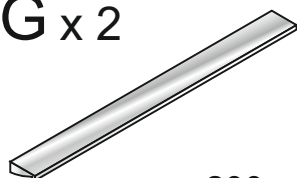

200 mm

J x 4

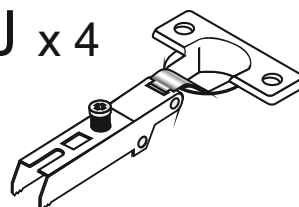

T x 8



4 x 16 mm

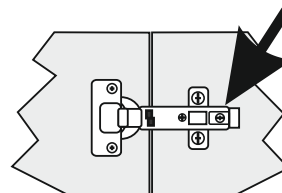
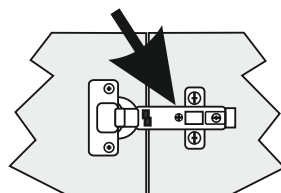
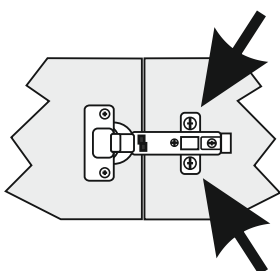
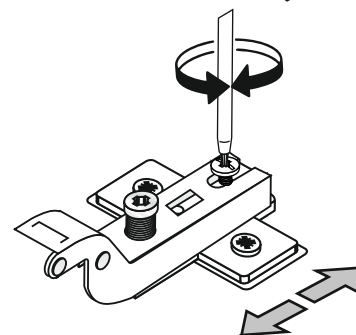
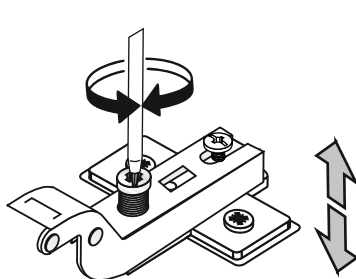
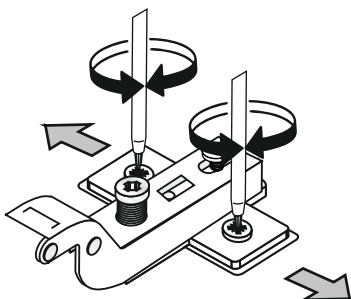
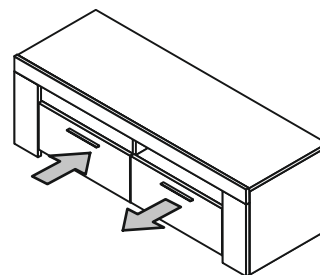
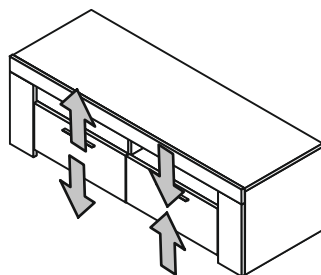
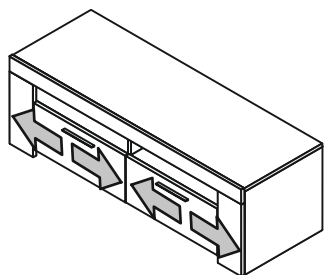
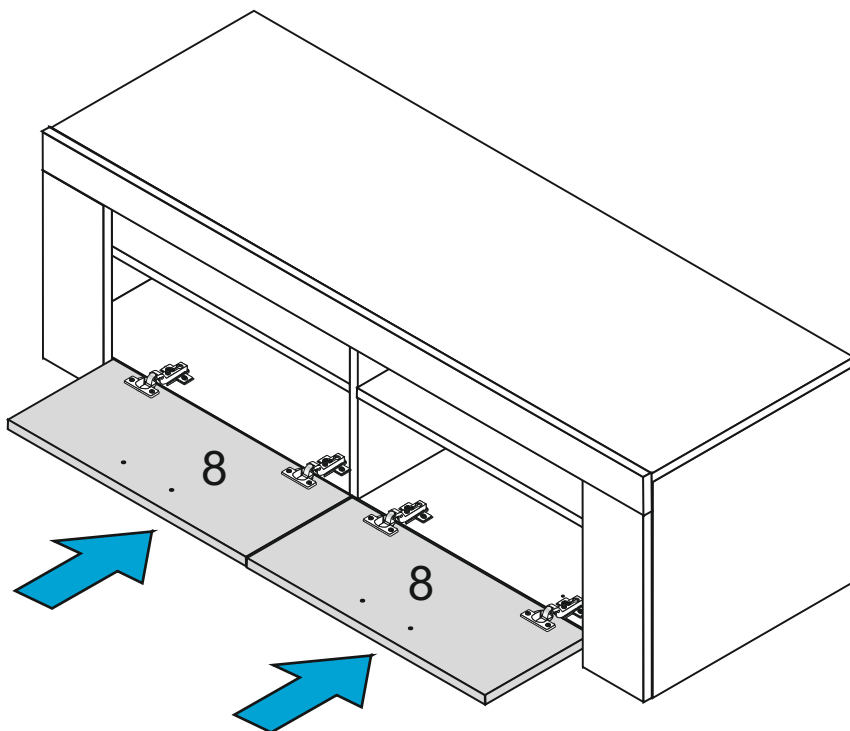
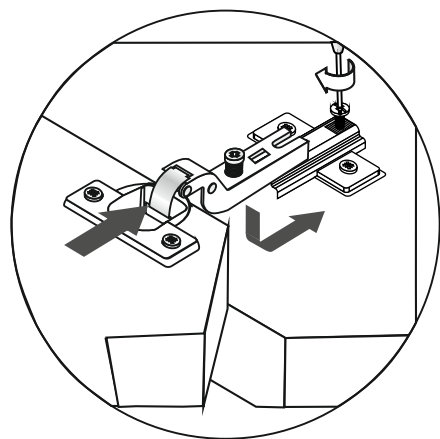

ES

RECOMENDACIONES PARA EL MONTAJE Y PARA EL USO

- Preparar las piezas que constituyen el mueble
- Reagrupar y contar el herraje
- Preparar las herramientas necesarias
- Prepara la zona de montaje
- Realizar el montaje sobre una moqueta para evitar rayar el mueble
- No forzar nunca los ensamblajes

- No colocar cerca de fuentes de calor
- No utilizar paños, trapos o productos de limpieza que puedan rayar la superficie del mueble
- Mueble apto para uso doméstico. Ubicación en el interior de la vivienda

IT

CONSEGLI PER L'INSTALLAZIONE E L'USO

- Preparate i componenti del mobile per il montaggio
- Ordinate e controllate la quantità della ferramenta
- Preparate gli attrezzi necessari
- Preparate un luogo idoneo al montaggio. Sistemate i componenti su un tappeto per non danneggiare le superfici
- Non forzate mai i componenti

- Non posizionate il mobile vicino a fonti di calore
- Non usate panni abrasivi né detersivi né solventi che possano danneggiare le superfici
- Questo prodotto è solo per uso domestico, non professionale. Non adatto per uso all'aperto

EN

RECOMMENDATIONS FOR FITTING AND FOR USE

- Prepare the pieces of furniture to make it up
- Group up and count the iron parts, screws... etc.
- Prepare the necessary tools
- Prepare the fitting place
- Do the fitting on a carpet so you don't damage the furniture
- Never force the fitting

- Do not put near to any sort of heat
- Do not use cloths or cleaning products that could damage the surface of the furniture
- Furniture suitable for domestic use, keep indoors

DE

MONTAGEHINWEISE UND GEBRAUCHSHINWEISE

- Sortieren und identifizieren Sie die Einzelteile
- Überprüfen Sie die Anzahl der einzelnen Beschlagteile
- Legen Sie das notwendige Werkzeug bereit
- Einen montagebereich freimachen
- Montieren Sie das Möbel auf einem ebenen, weichen, sauberen Untergrund
- Niemals die verbindungen zu stark anziehen

- Nicht neben Wärmequellen platzieren.
- Für die Reinigung verwenden Sie bitte ein weiches Tuch und keinesfalls scharfe oder ätzende Reinigungsmittel.
- Das Möbel ist ausschließlich für den Gebrauch im Haus geeignet.

FR

CONSEILS DE MONTAGE ET POUR L'USAGE

- Identifier les différents panneaux
- Regrouper et compter la quincaillerie
- Munissez-vous de l'outillage nécessaire
- Amenagez-vous une zone de montage. La moquette ou une couverture protégera des rayures
- Ne jamais forcer le montage

- Ne pas placer près des sources de chaleur
- N'utiliser pas de chiffons ou des produits de nettoyage qui puissent rayer la superficie du meuble
- Meuble apte pour l'usage domestique, on peut le placer à l'intérieur de la maison

GR

ΣΥΜΒΟΥΛΕΣ ΣΥΝΑΡΜΟΛΟΓΗΣΗΣ ΚΑΙ ΧΡΗΣΗΣ

- Προετοιμάστε τα μέρη του επίπλου
- Ομαδοποιήστε και μετρήστε τα μικρά μέρη (βίδες, μεντεσέδες...)
- Προετοιμάστε τα εργαλεία που θα χρειαστείτε
- Προετοιμάστε το χώρο συναρμολόγησης
- Μία μοκέτα θα προφύλασσε από γρατζουνιές
- Μη ασκείτε πίεση στην εφαρμογή
- Μη τοποθετείτε κοντά σε πηγή θερμότητας
- Μη χρησιμοποιείτε πανιά και καθαριστικά που μπορούν να καταστρέψουν την επιφάνεια
- Το έπιπλο έχει κατασκευαστεί για οικιακή χρήση, τοποθετήστε το στο εσωτερικό της οικίας

PT

AVISO PARA MONTAGEM E PARA USO

- Preparar as peças que compõem o móvel
- Reagrupar e contar as ferragens
- Preparar as ferramentas necessárias
- Prepara o local para a montagem
- Efectuar a montagem sobre uma alcatifa para evitar arranhar o móvel
- Não forçar nunca a ensambladura

- Não colocar perto de fontes de calor
- Não utilizar panos, trapos ou produtos de limpeza que possam riscar a superfície do móvel
- Móvel apto para o uso doméstico. Colocação no interior da vivenda

GARANTÍA - GUARANTEE - GARANTIE - GARANTIA - GARANZIA - GARANTIE - GARANTISI

- ES** · Fabricado en U.E. por FORES DISEÑO S.L. C.I.F: B-12313003 - Ctra.Nac.232; Km 11,1 C.P. 12320 - Sant Jordi (Castellón) SPAIN - el cual garantiza este producto por un periodo de **2 años** a partir de la fecha de compra, contra todo defecto de fabricación.
- Si se encuentra alguna dificultad a la hora del montaje o existe algún defecto en el mueble, puede contactar con nosotros al **964 46 52 22** o por e-mail: **postventa@fores.es** donde gustosamente atenderemos todas sus consultas. HORARIO: de lunes a viernes de 9h a 14h y de 15h a 18h.
- Esta garantía no ampara los defectos producidos por un mal montaje, utilización indebida o mal uso del mueble.
- Es imprescindible conservar el **ticket** de compra y facilitar el **Nº de Control de Calidad (Q.C.)** para cualquier consulta o reclamación.

- EN** · Manufactured in Spain by FORES DISEÑO S.L. CIF B-12313003-ctra Nac 232 km 11.1 C.P.12320-Sant Jordi, (Castellón) SPAIN - Guarantee of **2 years** from date of purchase against any fault of production.
- If a difficulty when assembly or a fault in the product is found you can contact us at **(+34) 964 46 52 22** or by email: **postventa@fores.es** where we will be pleased to help you. TIMETABLE: Monday until Friday 9-14h / 15-18h.
- The Guarantee does not cover the faults produced by an incorrect assembly or misuse of the furniture.
- Indispensable to keep the purchase **ticket** and facilitate the **Nº of Quality Control (Q.C.)** for any consult or claim.

- FR** · Fabriqué en UE par FORES DISEÑO S.L. CIF B-12313003 - Ctra Nac 232; Km 11,1 CP12320 - Sant Jordi (Castellón) Espagne - Celui ci garantie ce produit pour une période de **2 ans** à partir de la date d'achat, contre tout défaut de fabrication.
- Si vous rencontrez une quelconque difficulté à l'heure du montage ou si il y a un défaut sur le meuble, vous pouvez nous contacter par téléphone au **(+34) 964 46 52 22** ou bien par e-mail à **postventa@fores.es** où nous aurons le plaisir de vous accueillir pour toutes demandes. Nos HORAIRES sont du lundi au vendredi de 9H00 à 14H00 et de 15H00 à 18H00.
- Cette garantie ne couvre pas les défauts résultants d'un mauvais montage, d'une utilisation indue ou d'un mauvais usage du produit.
- Il est indispensable de garder le **ticket** ou facture d'achat et de communiquer le **Numéro de Control Qualité (Q.C.)** pour une quelconque demande ou réclamation.

- PT** · Fabricado U.E. por FORES DISEÑO S.L. C.I.F: B-12313003 - Ctra.Nac.232; 11,1 km C.P. 12320 - Sant Jordi (Castellón) ESPANHA - que garante este produto por um período de **2 anos** a partir da data de compra; contra defeitos de fabricação.
- Se você encontrar qualquer dificuldade na montagem ou se houver qualquer defeito no armário, você pode contactar-nos pelos seguintes meios: **(+34) 964 46 52 22** ou por e-mail: **postventa@fores.es** onde será recebido de bom grado para atenderder-mos todas as suas dúvidas. HORÁRIOS: Segunda a sexta-feira das 9h às 14h e 15h às 18h.
- Esta garantia não cobre defeitos causados pela montagem incorreta, uso indevido ou mau trato do produto.
- É essencial manter o **recibo** de compra e facilitar o **Nº Controle de Qualidade (Q.C.)** para quaisquer dúvidas ou reclamações.

- IT** · Prodotto in Spagna da: FORES DISEÑO S.L. CIF B-12313003-ctra Nac 232 km 11.1 C.P.12320-Sant Jordi, (Castellón) SPAIN. Garantisito **2 Anni** dalla data di acquisto contro ogni difetto di produzione.
- In caso di difficoltà nel montaggio o di mancanza di componenti potete chiamare il **(+34) 964 46 52 22** o inviare email a: **postventa@fores.es**
- Il servizio è attivo dal Lunedì al Venerdì ore 9:00-14:00 / 15:00-18:00 Saremo lieti di aiutarvi.
- La garanzia non copre difetti o danni dovuti a montaggio scorretto o ad uso improprio del prodotto.
- La garanzia è valida solo in presenza dello **sccontrino di acquisto** e sarà più tempestiva se conservate il **nº di controllo qualità (Q.C.)** presente nella confezione.

- DE** · Hergestellt in Spanien von FORES DISEÑO S.L. CIF B-12313003-ctra Nac 232 km 11.1 CP12320-Sant Jordi (Castellón) SPANIEN - Garantie von **2 Jahren** ab Kaufdatum gegen jede störung der produktion.
- Wenn Sie irgendwelche schwierigkeiten bei der montage zu finden oder es irgendeinen defekt in dem schrank, können sie uns unter **(+34) 964 46 52 22** oder per email an: **postventa@fores.es**, wo wir gerne besuchen, um alle Ihre Fragen. ÖFFNUNGSZEITEN: Montag bis Freitag von 9h bis 14h und 15h bis 18h.
- Diese Garantie gilt nicht für Mängel, die durch unsachgemäße Installation, unsachgemäße Behandlung und Verwendung des Geräts verursacht werden.
- Unentbehrlich, um den **Kauf Ticket** behalten und erleichtern die Anzahl der **Qualitätskontrollzahl (Q.C.)** für alle zu konsultieren oder Anspruch.

- GR** · Κατασκευάζεται στην Ισπανία από CIF B-12313003-Ctra Nac 232 χλμ 11.1 CP12320-Sant Jordi, στην Ισπανία - Η εγγύηση ισχύει για **2 έτη** από την αρχική ημερομηνία αγοράς και καλύπτει ελαττωματικά υλικά ή ελαττωματική κατασκευή του προϊόντος.
- Σε περίπτωση δυσκολίας σας κατά την συναρμολόγηση ή πιθανής βλάβης στο προϊόν, μπορείτε να επικοινωνήσετε μαζί μας στο **(+34) 964 46 52 22** ή μέσω email: **postventa@fores.es** Θα χαρούμε να σας βοηθήσουμε. ΗΜΕΡΕΣ ΣΥΝΑΡΜΟΛΟΓΗΣΗΣ: Δευτέρα έως Παρασκευή 9:00-14:00 & 15:00-18:00.
- Η εγγύηση δεν καλύπτει τις βλάβες που προέρχονται από λάθη στην συναρμολόγηση ή την μη ορθολογική χρήση των επίπλων.
- Είναι απαραίτητο να κρατήσετε την **απόδειξη αγοράς** του προϊόντος και τον **αριθμό ποιοτικού ελέγχου (Q.C.)**, ώστε να διευκολύνετε οποιαδήποτε διαδικασία αίτησης ή συμβουλής χρειαστείτε.

Nº de Control de Calidad (Q.C.):
Nº of Quality Control (Q.C.):
Nº de Contrôle Qualité (Q.C.):
Nº de Controle de Qualidade (Q.C.):
Nº di Controllo qualità (Q.C.):
Qualitätskontrollzahl (Q.C.):
Ποιοτικός έλεγχος Αριθμός (Q.C.):



GUARDE ESTE NÚMERO
SAVE THIS NUMBER
SAUVEZ CE NUMÉRO
GUARDE ESTE NÚMERO
SALVA QUESTO NUMERO
SPEICHERN SIE DIESE NUMMER
ΦΥΛΑΞΤΕ ΑΥΤΟ ΤΟ ΑΡΙΘΜΟ

Q.C.
00000.17



**SALÓN TV - TV LIVING ROOM - SÉJOUR TV - MÓVEL PARA SALA -
TV SOGGIORNO - FERNSEHRAUM - NAMJEŠTAJ ZA TV - ΈΠΙΠΛΑ ΓΙΑ ΤΟ ΣΑΛΟΝΙ**

